

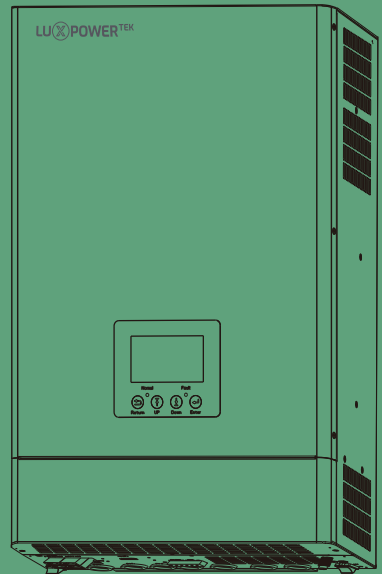

Off-grid Inverter User Manual

SNA 3000-6000 WPV



Copyright© 2024 Lux Power Technology Co., Ltd. All Rights Reserved. This manual, protected by the copyright and intellectual property rights of Lux Power Technology, may not be modified, copied, or reproduced without prior written permission. Brands and trademarks mentioned belong to their respective owners. Read carefully for product reliability and warranty eligibility. For warranty details, refer to Lux Power Technology Limited Warranty. Intended for professional service providers; no statements constitute an express or implied warranty.

Descriptions may contain predictive statements; differences may occur. Provided for reference, subject to change without notice by Lux Power Technology.



Website



YouTube



Facebook

 www.luxpowertek.com



Scan to download

Table Of Contents

- Information on this Manual** 1
- Validity 1
- Scope 1
- Target Group 1
- Safety Instructions 1
- 1. Brief Introduction** 2
- 1.1 Features of the inverter 2
- 1.2 Interface of the inverter 3
- 1.3 Packing list 4
- 2. Installation** 6
- 2.1 Preparation 6
- 2.2 Mounting the Unit 8
- 2.3 Battery Connection 9
- 2.3.1 Battery Power Cable Connection 9
- 2.3.2 Lithium Battery Connection 9
- 2.4 CT 10
- 2.5 AC Input/Output Connection 12
- 2.6 PV Connection 13
- 2.7 Working with Generator 13
- 2.8 Smart load Connection 17
- 2.9 AC Coupling Settings 18
- 2.10 Parallel Function 19
- 2.11 Power and EPS ON/OFF 22
- 3. Working Modes** 22
- 3.1 Offgrid inverter modes introduction 22
- 3.2 Working Modes related setting description 24
- 3.3 Working as a hybrid inverter Related setting 25
- 4. LCD Display and settings** 26

4.1 LED Display 26

4.2 LCD Display 26

4.3 Inverter Status Display 28

4.4 LCD Settings 29

5. Monitor System for ECO Hybrid inverter 43

6. Specifications 44

7. Trouble Shooting & Error List 48

Revision History

Version	Date	Description
UM-SNA01001	2024.07.19	First official release.
UM-SNA01001-01	2024.09.13	Added descriptions and settings for GEN interface, including Smart Load and AC Coupling functionality.

Information on this Manual

Validity

This manual is valid for the following devices: SNA3000 WPV/SNA4000 WPV/SNA5000 WPV/SNA6000 WPV

Scope

This manual provides the installation, operation and troubleshooting of this unit, please read this manual carefully before installations and operations.

Target Group

For qualified persons and end users. Qualified persons and end users must have the following skills:

- Knowledge about this unit's operation
- Training on security issues associated with installations and electrical safety
- Training in the installation and commissioning of electrical devices and installations.
- Knowledge of the applicable local standards and directives.

Safety Instructions

WARNING: This chapter contains important safety and operating instructions. Read and keep this manual for future reference.

- All operations and connections need to be carried out by qualified persons.
- Before using the unit, read all instructions and cautionary markings on the unit. Any damage caused by inappropriate operation is not warranted by Sun King .
- All the electrical installations must comply with the local electrical safety standards.
- Do not disassemble the unit. Take it to a qualified service center when service or repair is required, incorrect re-assembly may result in a risk of electric shock or fire. Do not open inverter cover or change any components without Luxpower's authorization, otherwise the warranty commitment for the inverter will be invalid.
- To reduce risk of electric shock, disconnect all wirings before attempting any maintenance or cleaning. Turning off the unit will not reduce this risk.
- **CAUTION-**To reduce risk of injury, charge only deep-cycle lead-acid type rechargeable batteries and lithium batteries, other types of batteries may burst, causing personal injury and damage.
- **NEVER** charge a frozen battery.
- For optimum operation of this unit, please follow the required specifications in selecting the appropriate cable size and circuit breaker
- Please strictly follow installation procedure when you want to disconnect AC or DC terminals. Refer to the installation section of this manual for details.
- **GROUNDING INSTRUCTIONS** -This unit should be connected to a permanent grounded wiring system. Be sure to comply with local requirements and regulations when installing this inverter.
- Never short circuit the AC and DC outputs. Do not connect to the mains when the DC input is short circuited.

1. Brief Introduction

1.1 Features of the inverter

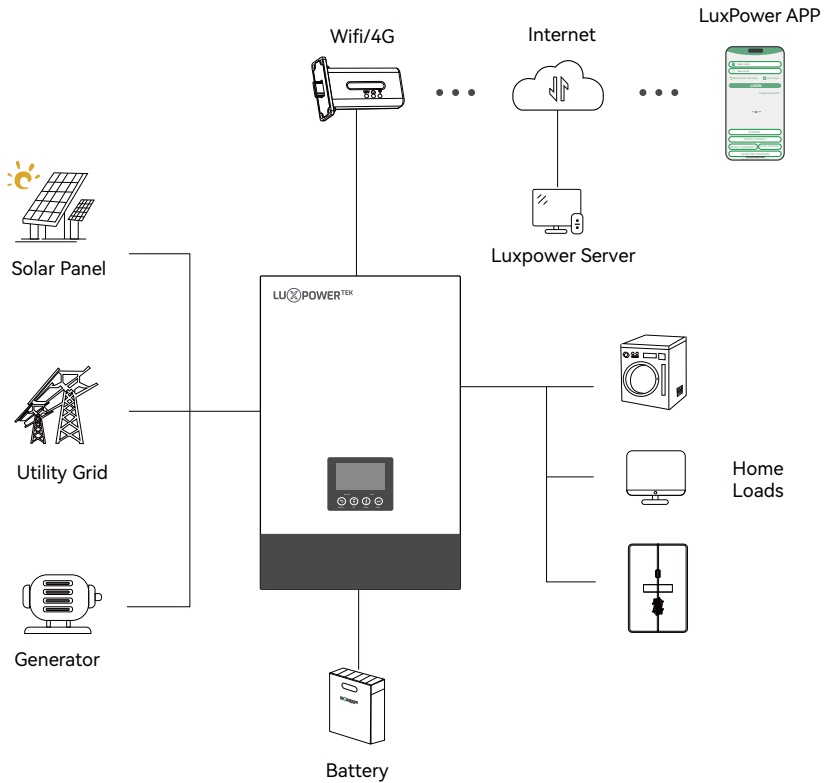

This is a multifunctional, high frequency pure sine wave hybrid solar inverter.

- Applicable for pure off grid inverter/backup power/self-consumption/ongrid situation.
- Integrated with 2 MPPT solar charge controllers, MPPT ranges 120V~385V.
- Rated power factor 1
- Able to run with or without battery connection
- With separated generator input interface, able to control generator remotely.
- Solar and utility grid can power loads at the same time.
- With integrated advanced parallel function. Up to 16 inverters connected in parallel.
- Support CAN/RS485 for Li-ion battery BMS communication.
- WIFI/GPRS remote monitoring , setting and firmware update, support website, free IOS/Android APP.

1.2 Interface of the inverter

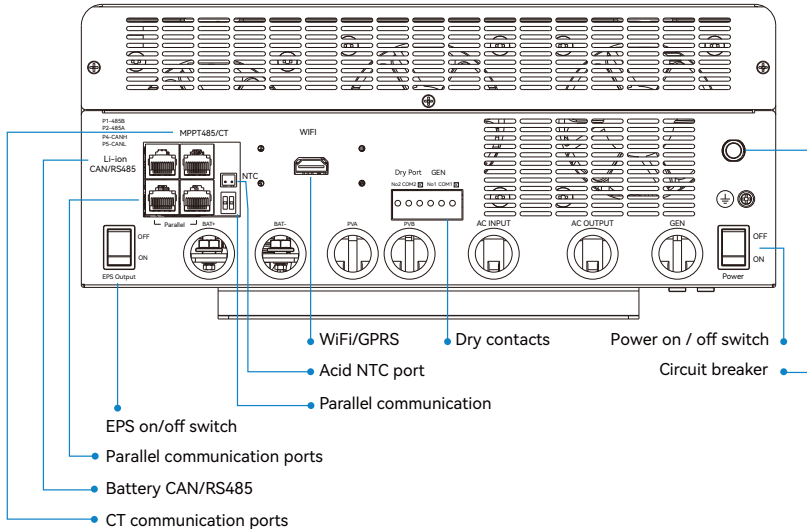
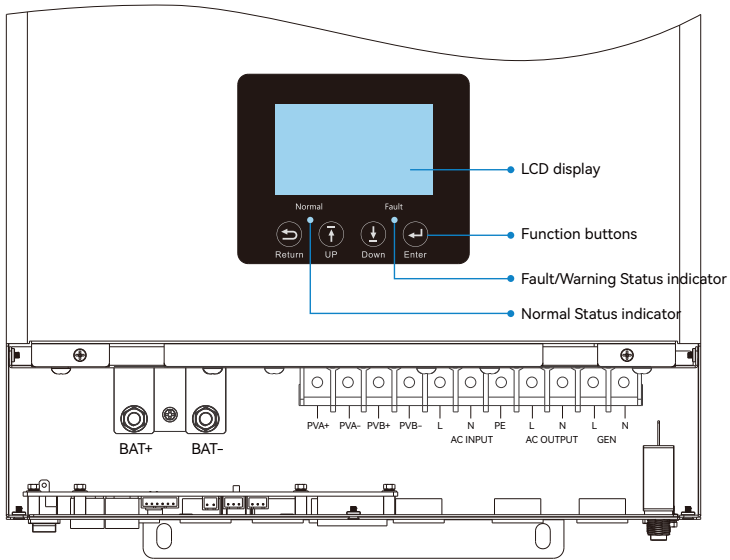

1.3 Packing List

Before installation, please inspect the unit. Be sure that nothing inside the package is damaged.

You should have received the following items in the package:

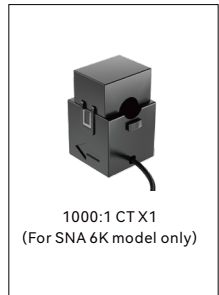
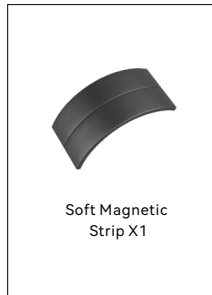
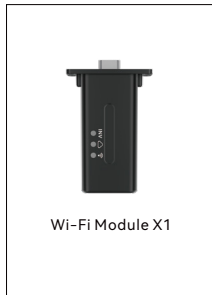
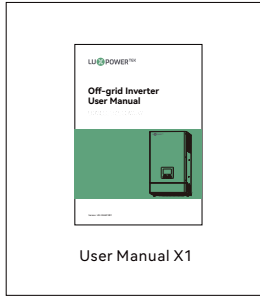

Storing the Inverter

The inverter must be stored appropriately if not installed immediately, refer to below figure.

CAUTION

- a) The inverter and its components must be stored in its original packaging.
- b) The storage temperature should be within -25~60 and humidity within 0~85%.
- c) The packing should be upright and maximum stacked layers is 6.
- d) Do not directly exposed the inverter and its packaging to sunshine, raindrops and keep away from corrosion.

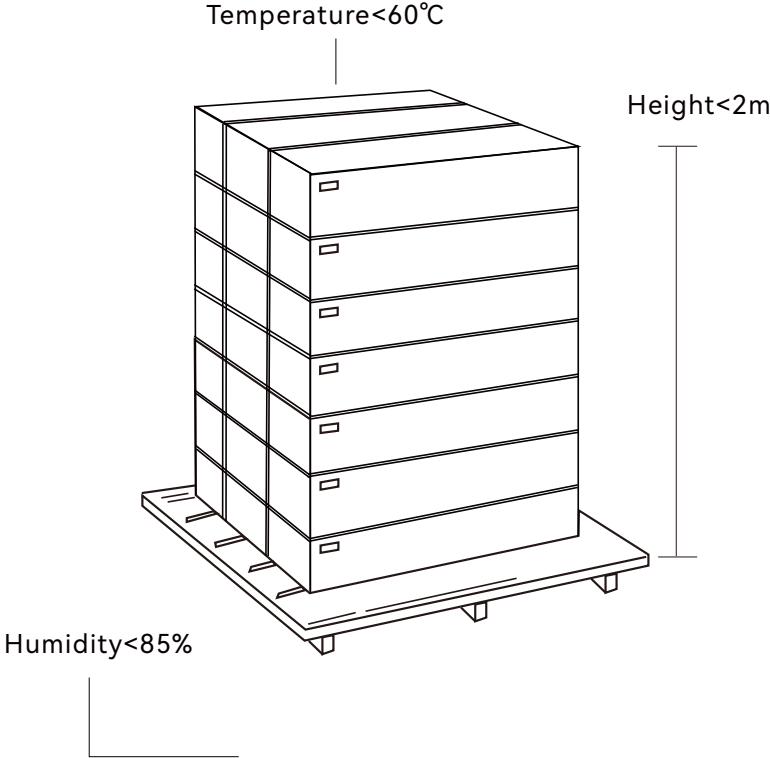

2. Installation

2.1 Preparation

The system connection is as below:

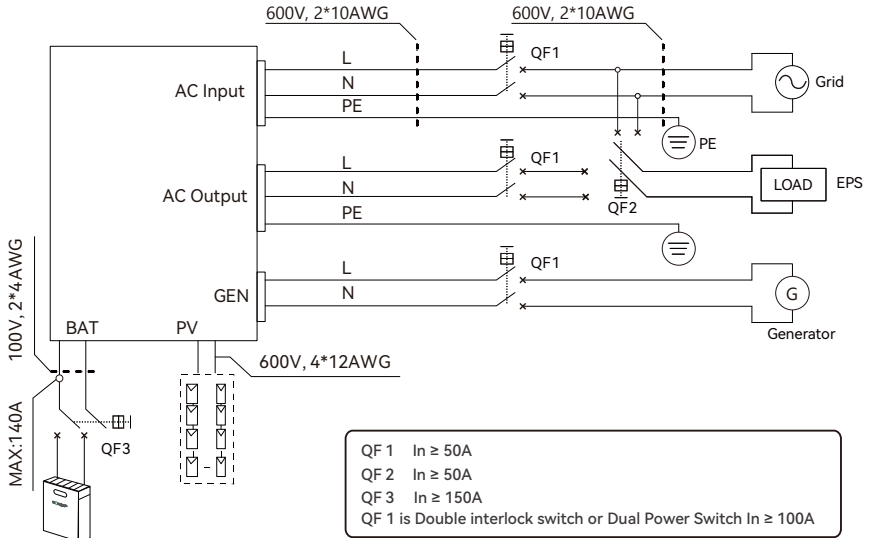

Please prepare the breakers and cables in advanced before installation.

1. Battery connection: For safe operation and regulatory compliance, please install a separate DC over-current protector or disconnect device between battery and inverter. The recommend battery capacity is 150AH-200AH, the recommended spec of DC breaker is SNA5000WPV 150A/80V, SNA6000WPV 200A/80V. Recommended battery cable and terminal size:

Model	Maximum Amperage	Battery capacity	Wire Size	Ring Terminal			Torque value
				Cable mm ²	Dimensions D (mm) L (mm)		
SNA5000WPV	110A	≥200A	1/2AWG	33	6.4	39.2	4~5 N·m
SNA6000WPV	140A		1/1AWG	42	6.4	39.2	

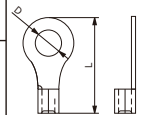

2. **AC connection:** Please install a separate AC breaker between inverter and AC input power source, inverter and AC output load. This will ensure the inverter can be securely disconnected during maintenance and fully protected from over current of AC input. The recommended spec of AC breaker is 50A. Recommended AC input/AC output/GEN cable size for each inverter.

Model	Gauge	Cable (mm ²)	Torque Value
SNA5000WPV/6000WPV	10AWG	6	2.0 N·m

3. **PV Connection:** Please install separately a DC circuit breaker between inverter and PV modules. The recommended of DC breaker is 600V/25A. It's very important for system safety and efficient operation to use the appropriate cable for PV module connection. To reduce risk of injury, please use the proper recommended cable size as below:

Model	Gauge	Cable (mm ²)	Torque Value
SNA5000WPV/6000WPV	1x10AWG	6	2.0 N·m

4. Before connecting all wiring, please take off bottom cover by removing 3 screws as shown below.

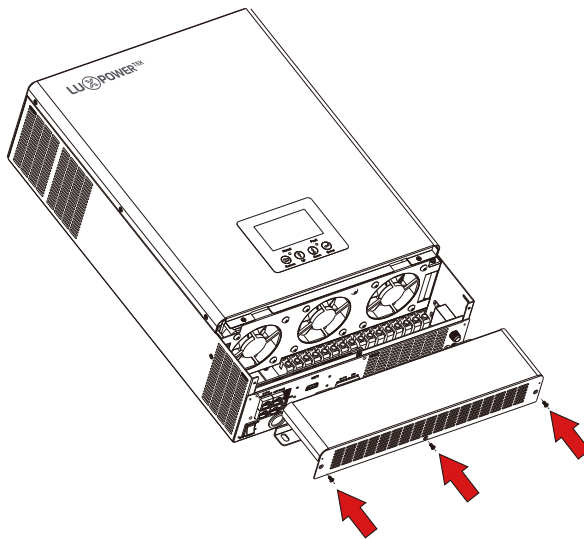

2.2 Mounting the Unit

● NOTICE

Consider the following points before selecting where to install:

- Mount on a solid surface.
- Do not mount the inverter on flammable construction materials.
- For proper air circulation to dissipate heat, allow a clearance of approx. 20cm to the side and approx. 50cm above and below the unit.
- The ambient temperature should be between 0°C and 55°C to ensure optimal operation.
- The recommended installation position is to be adhered to the wall vertically.

Steps to mounting the unit

Step 1. Use the wall-mounting bracket as the template to mark the position of the 4 holes, then drill 8 mm holes and make sure the depth of the holes is deeper than 50mm.

Step 2. Install the expansion tubes into the holes and tight them, then use the expansion screws (packaged together with the expansion tubes) to install and fix the wall-mounting bracket on the wall.

Step 3. Install the inverter on the wall-mounting bracket and lock the inverter using the security screws.

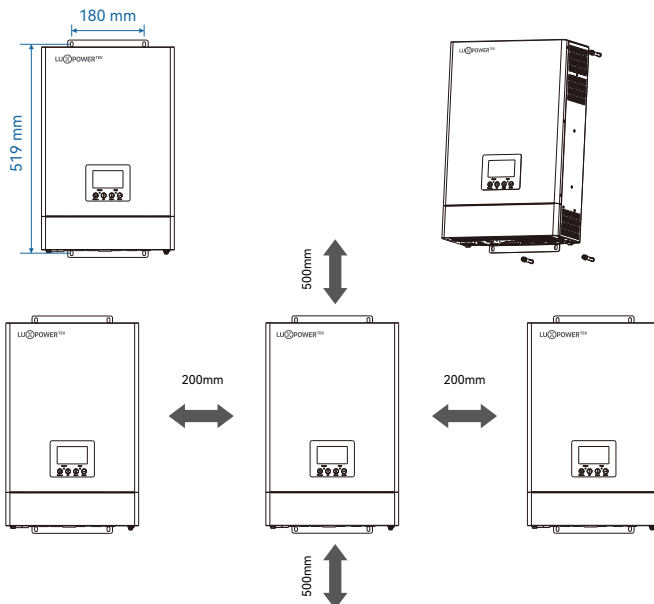

2.3 Battery Connection

2.3.1 Battery Power Cable Connection

Note: For lead acid battery, the recommended charge current is 0.2C (C to battery capacity).

1. Please follow below steps to implement battery connection:
2. Assemble battery ring terminal based on recommended battery cable and terminal size.
3. Connect all battery packs as units requires. It's suggested to connect at least 200Ah capacity battery for SNA5000WPV/6000WPV.
4. Insert the ring terminal of battery cable flatly into battery connector of inverter and make sure the bolts are tightened with torque of 4~5N·m. Make sure polarity of the battery is correctly connected and ring terminals are tightly screwed to the battery terminals.

2.3.2 Lithium Battery Connection

If choosing lithium battery for SNA series, please make sure the battery BMS is compatible with Luxpower inverter. Please check the compatible list in the Luxpower website.

Please follow below steps to implement lithium battery connection:

1. Connect power cable between inverter and battery
2. Connect the CAN or RS485 communication cable between inverter and battery. If you do not get the communication cable from inverter manufacturer or battery manufacturer, please make the cable according to the PIN definition
3. Lithium battery configuration, in order to communicate with battery BMS, you should set the battery type to “Li-ion” in Program “03” by LCD and choose the right battery brand (for details, please check the LCD setting chapter), users can also choose the battery type and brand by monitor system. If using a Luxpower battery, select lithium type for option 6: Luxpower; for Hina battery, select lithium type option 1: Hina Battery.

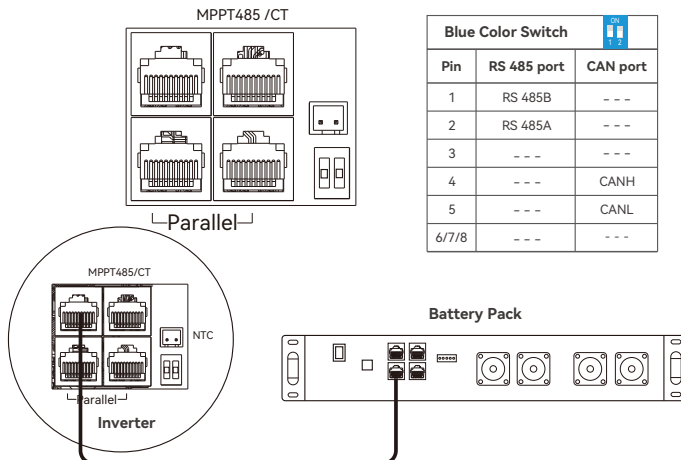

2.4 CT

To measure the power imported from and exported to the grid, the CT must be installed at the service entry point in or near the main service panel. "External Grid CT" function is off by default, and if you need inverter to export power to compensate the grid loads, you can set "External Grid CT" function to "Enable" state. Please refer to section 4.4 LCD Settings for detected setting info.

CT Port Pin definitio

The CT interface for CT connection is a RJ45 port.

Pin	Description
	CT
1/3	B
2/4	A
5	CT1N
6	CT1P
7	B2
8	A2

Pin12345678



MPPT485/CT

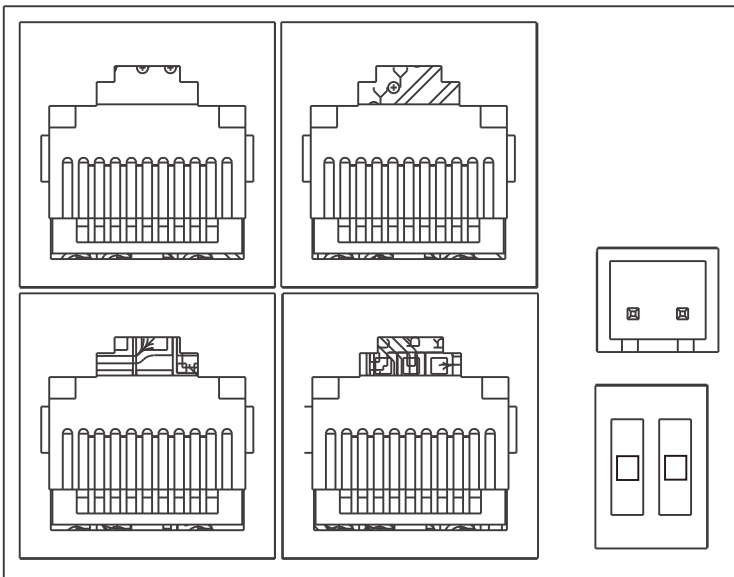

NTC

Parallel

Please refer to the connection diagram for the correct positions of Grid CT and clamp the CT on the wires at the service entry point in the main service panel. The arrow on the CT is pointing to the inverter. (***) Incorrectly install CT will cause The Display to show incorrect information and features of the inverter will not function correctly) If the CT is in a wrong direction, there is an option you can change the direction of the CT on your inverter call: CT Direction Reversed in Advanced Tab. You would not need to go change it physically.

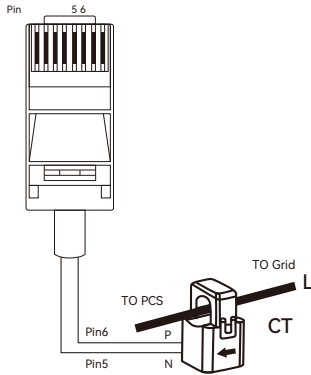

CT Clamp Ratio

The inverter support 3 ratios of CT clamp-1000:1, 2000:1 and 3000:1. The CT ratio in the accessory bag is 1000:1. If you are using a 3rd party CT, please ensure the CT ratio is one of them, and select the correct CT ratio setting in the inverter monitor page or on the inverter LCD.

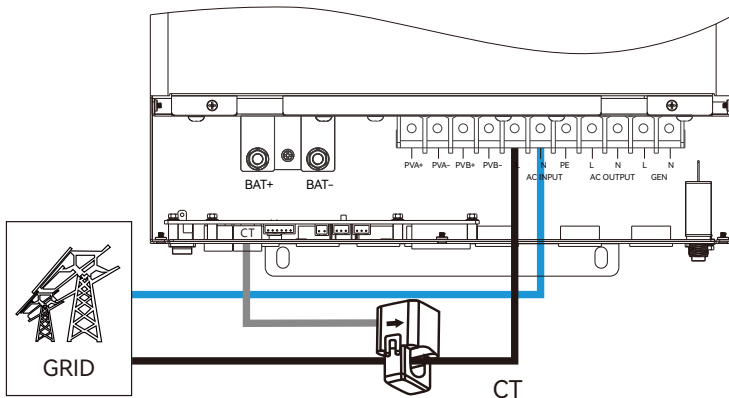

2.5 AC Input/Output Connection

CAUTION

- There are two terminal blocks with “IN” and “OUT” markings. Please do NOT mis-connect input and output connectors.
- Be sure to connect AC wires with correct polarity. If the L and N wires are connected in reverse, it may cause a short circuit when the inverters are connected in parallel.

Please follow the steps below to implement the AC input/output connection:

1. Before making the connection, ensure you open the DC protection device or disconnect it FIRST.
2. Remove 10mm of the insulation sleeve for the six conductors and shorten the L and N conductors by 3mm.
3. Insert AC input wires according to polarities indicated on terminal block and tighten the terminal screws. Be sure to connect PE protective conductor first.
4. Insert AC output wires according to polarities indicated on terminal block and tighten terminal screws. Be sure to connect PE protective conductor first.
5. Make sure the wires are securely connected.

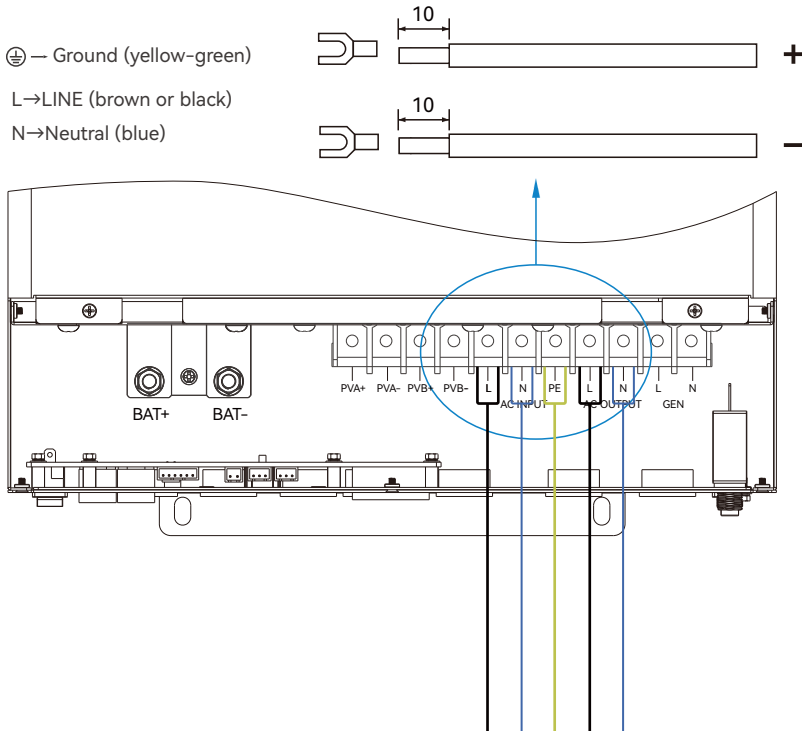

2.6 PV Connection

Please follow below steps to implement PV module connection:

1. Remove 10mm of the insulation sleeve from the positive and negative conductors.
2. Check correct polarity of connection cable from PV modules and PV input connectors.
3. Connect positive pole (+) of connection cable to positive pole (+) of PV input connector. Connect negative pole (-) of connection cable to negative pole (-) of PV input connector.
4. Make sure the wires are securely connected.

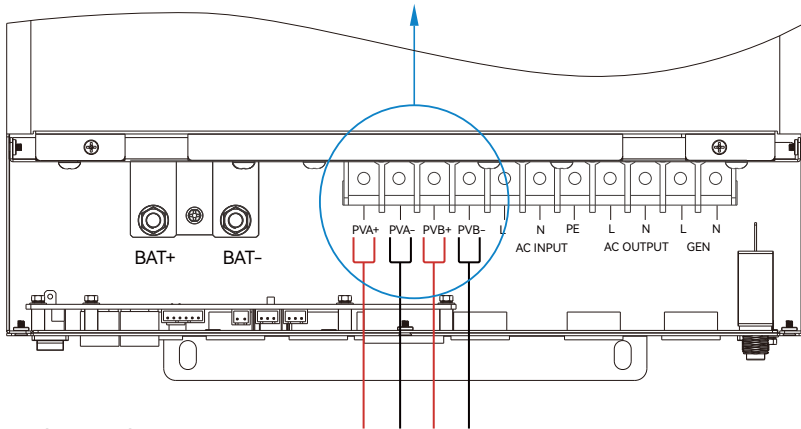

2.7 Working with Generator

L→LINE (brown or black) N→Neutral (blue)

1. Before making Generator connection, be sure to open DC protector or disconnected first.
2. Remove insulation sleeve 10mm for 2 conductors.
3. Insert L and N wires according to polarities indicated on terminal block and tighten the terminal screws.
4. Make sure the wires are securely connected.
5. Finally, after connecting all wiring, please put bottom cover back by screwing two screws as shown below.

All lux units can work with generator:

- Users can connect the generator output to ECO hybrid inverters. GEN input terminal.
- The generator will be automatically started when battery voltage is lower than the cut-off value or there is charge request from BMS. When voltage is higher than AC charge setting value, it will stop the generator.
- Battery will get charged when the generator is turned on, and the generator is bypassed to AC output to take all loads.
- The system will use AC first if there is both utility input and generator input.

2.7.1 Generator system connection

The SNA series can use a generator for backup power during grid failures. When selecting a generator, ensure it provides sufficient power and maintains a frequency with a Total Harmonic Distortion (THD) of less than 3%. As a general guideline, the generator should be at least 1.5 times the inverter's output to accommodate both load powering and battery charging. The table below lists the recommended generator capacities for optimal performance.

Number of inverters in parallel	Generator Capacity
1	>10KW
2	>15KW
3	>20KW
4	25KW

This SNA5K/6K product can work with a generator and includes a dedicated Gen port for generator connection.

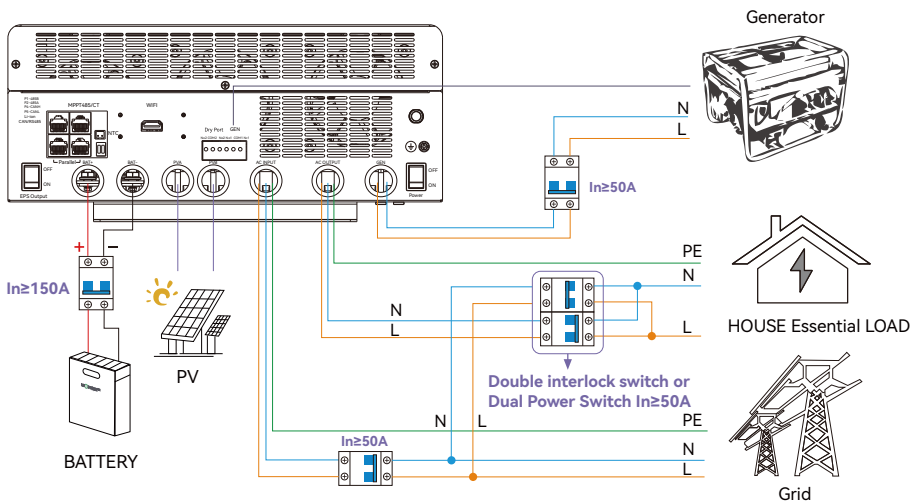

When properly wired and configured, the generator, if compatible with remote start, will start automatically when the battery voltage / SOC is lower than the cut-off value or there is a charge request from the BMS. When the generator is running, it will charge the batteries and excess AC power will be diverted to the AC output (LOAD) to power loads.

2.7.2 Integrated two-wire Start/Stop

The Dry port (NO2, COM2) could be used to deliver signal to external device when battery voltage reaches warning level. The GEN port (NO1, COM1) could be used to wake-up the Generator and then the generator can charge the battery.

Reminder:

Notice: NO---Normal open

Dry Port Relay Maximum Specification: 250VAC 5A

Gen Port Relay Maximum Specification: 250VAC 5A

Unit Status	Condition		Dry port NO2 COM2	GEN NO1 COM1
			NO2 & COM2	NO1 & COM1
Power Off	Inverter is off and no output is powered.		Open	Open
Power On	Without Grid	Battery voltage < Low DC warning voltage	Close	Close
		Battery voltage > Setting value or battery charging reaches floating stage	Open	Open
	With Grid	Battery voltage < Low DC warning voltage	Close	Open
		Battery voltage > Setting value or battery charging reaches floating stage	Open	Open

2.7.3 Generator AC connection

Please follow the steps listed below to ensure the generator connections are properly installed.

Step 1. Before making any wiring connections, ensure the inverter(s) are powered off, the generator is powered off, and all circuit breakers are open (off) to prevent damage to the unit.

Step 2. Properly identify the generator’s output lines. According to European wiring standards, the Live (L) wire will be black, Neutral (N) will be blue, and Ground (PE) will be green/yellow. Once identified, strip approximately 10mm (≈3/8 in.) of insulation from the wires.

Step 3. Ground the generator’s output ground to the Ground Bus (labeled PE) of the inverter.

Step 4. Connect the Live (L) wire to the GEN port’s L terminal and the Neutral (N) wire to the GEN port’s N terminal.

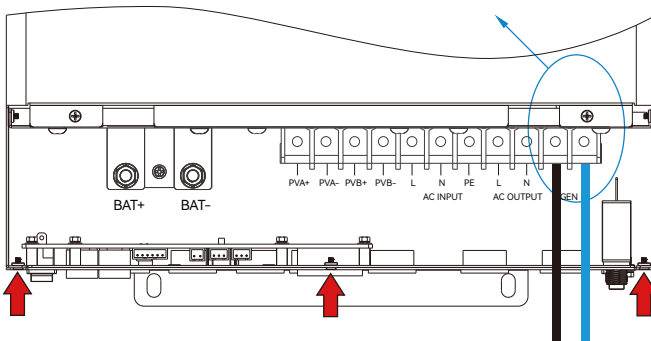

2.7.4 Generator start and stop settings

Using the Luxpower Monitoring Software, navigate to the “Maintenance” page where “Remote Set” will be automatically selected. Scroll to the “Generator” section and select the “Generator Charge Type” (see screenshot below). Typically, lead-acid batteries are charged based on voltage, while lithium batteries are charged based on SOC (State of Charge).

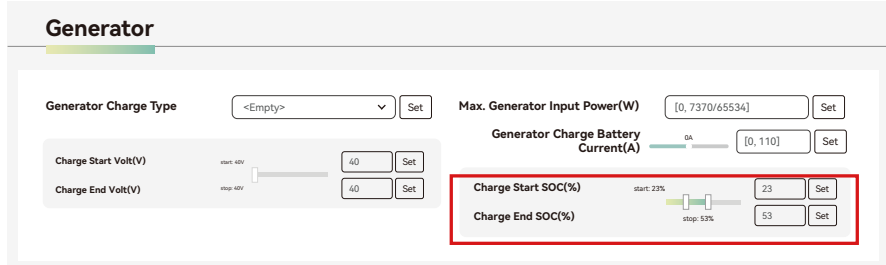
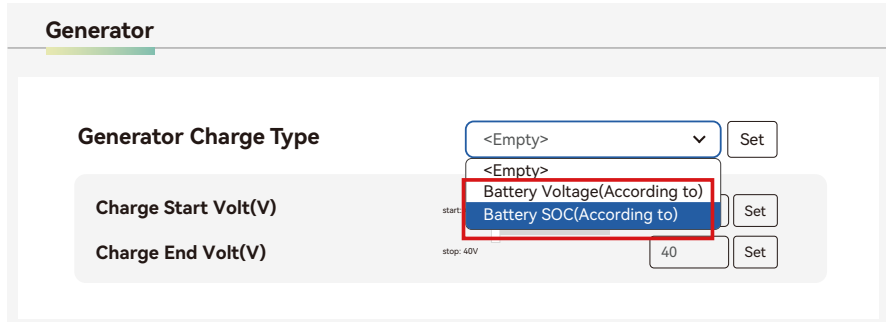

Generator Start Conditions:

The generator will start when utility fails and one of the following conditions is met:

- The battery is discharged to the cut-off setting
- There is a force charge request from the battery
- The battery voltage or SOC is lower than the “Generator Charge Start Battery Volt / SOC” setting

Generator Stop Conditions:

The generator will stop when the battery voltage or SOC is higher than the “Generator Charge End Battery Volt / SOC” settings.

2.7.5 Gen Boost Function

In real applications, customer loads often fluctuate, making generators highly sensitive to frequent changes. Activating GEN Boost can allocate a margin for the generator's input power, preventing it from consistently operating near overload conditions.

Enable GEN boost

GEN Function

Generator **Smart Load**

Generator Boost

Generator Charge Type <Empty>

Charge Start Volt(V) start: 40V

Charge End Volt(V) stop: 40V

2.8 Smart load Connection

The SNA 3-6K's dedicated generator port can also connect to various smart loads, such as water heaters, in addition to generators.

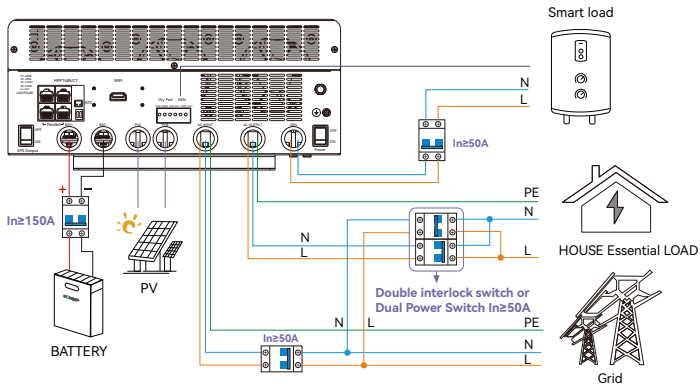

2.8.1 Smart Load Settings

Enable smart load

Generator **Smart Load**

Smart Load

Grid Always On

Start PV Power(kW) {0.25.5}

Smart Load Start SOC(%) off-grid 0%

Smart Load End SOC(%) on-grid 0%

Smart Load Start Volt(V) off-grid 40V

Smart Load End Volt(V) on-grid 40V

Enable “Grid always on”: When connected to the grid, the smart load remains continuously connected.

Start PV Power: Input the PV power threshold at which you want the smart load to start. You can also input the battery’s SOC or voltage to select when to start and stop.

If your home already has an existing grid-tied system, you can connect it to our generator interface as an AC power input, transforming your grid-tied system into an energy storage system.

2.9 AC Coupling Settings

The AC Coupling setting must be enabled when connecting an existing on-grid system to the GEN port.

- Start SOC(%): The SOC at which the AC-coupled inverters are turned on when in off-grid mode (50% to 70% recommended).
- End SOC(%): The SOC at which the AC-coupled inverters are shut down when in off-grid mode (90% recommended).

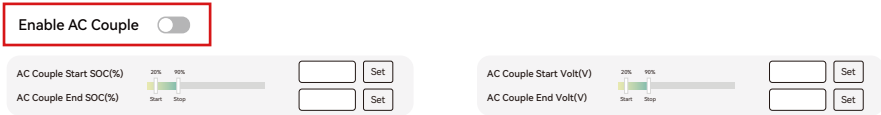

When on-grid and export to grid are enabled, the AC-coupled inverter will always be on, selling any extra power back to the grid. Ensure you are permitted to sell power to your utility provider when using AC-coupled PV arrays on-grid.

Note: It is recommended to keep the Start Volt/SOC and End Volt/SOC within 5%-10% of each other for optimal operation when utilizing the AC coupling function.

Hybrid Setting

PV&AC Take Load Jointly	<input type="button" value="Enable"/> <input type="button" value="Disable"/>
Grid CT Connection	<input type="button" value="Enable"/> <input type="button" value="Disable"/>
Export to Grid	<input type="button" value="Enable"/> <input type="button" value="Disable"/>
CT Power Offset(W)	<input type="text" value="[-199,199]"/> <input type="button" value="Set"/>
Export Power Percent(%)	<input type="text" value="[0,100]"/> <input type="button" value="Set"/>

2.10 Parallel Function

SNA series inverter support up to 18 units to composed single phase parallel system or three phase parallel system, for parallel system setup

Step 1. Cable connection: the system connection is as below:

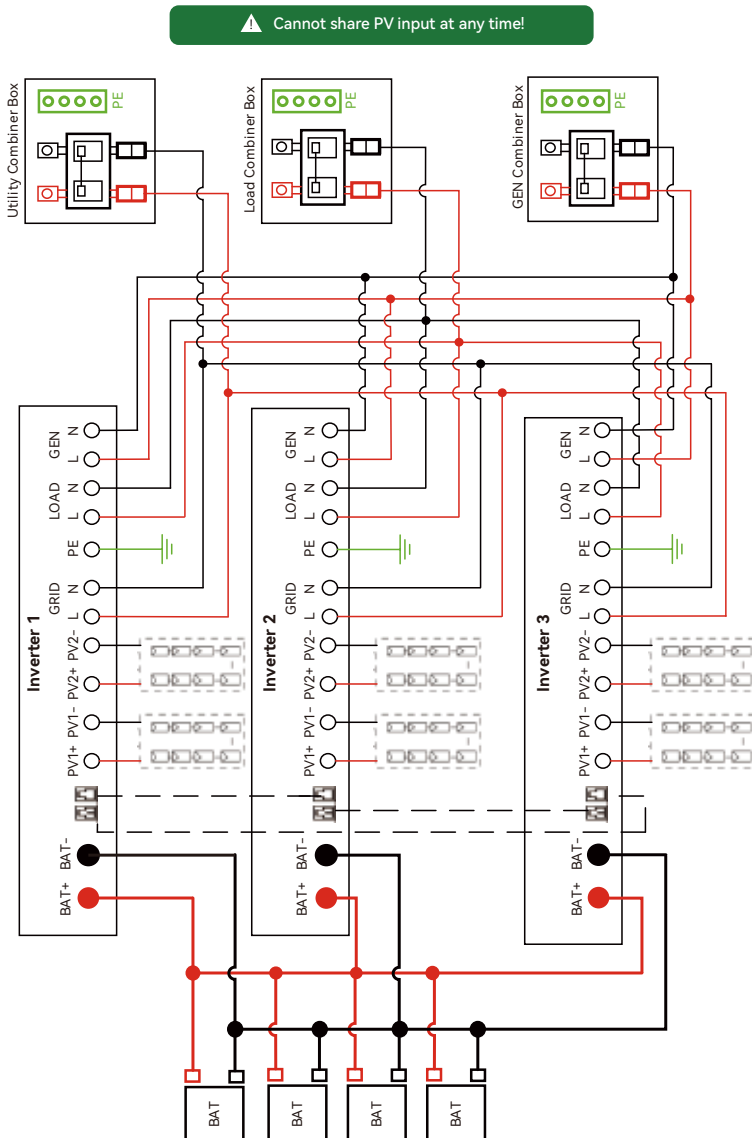

⚠ Cannot share PV input at any time!

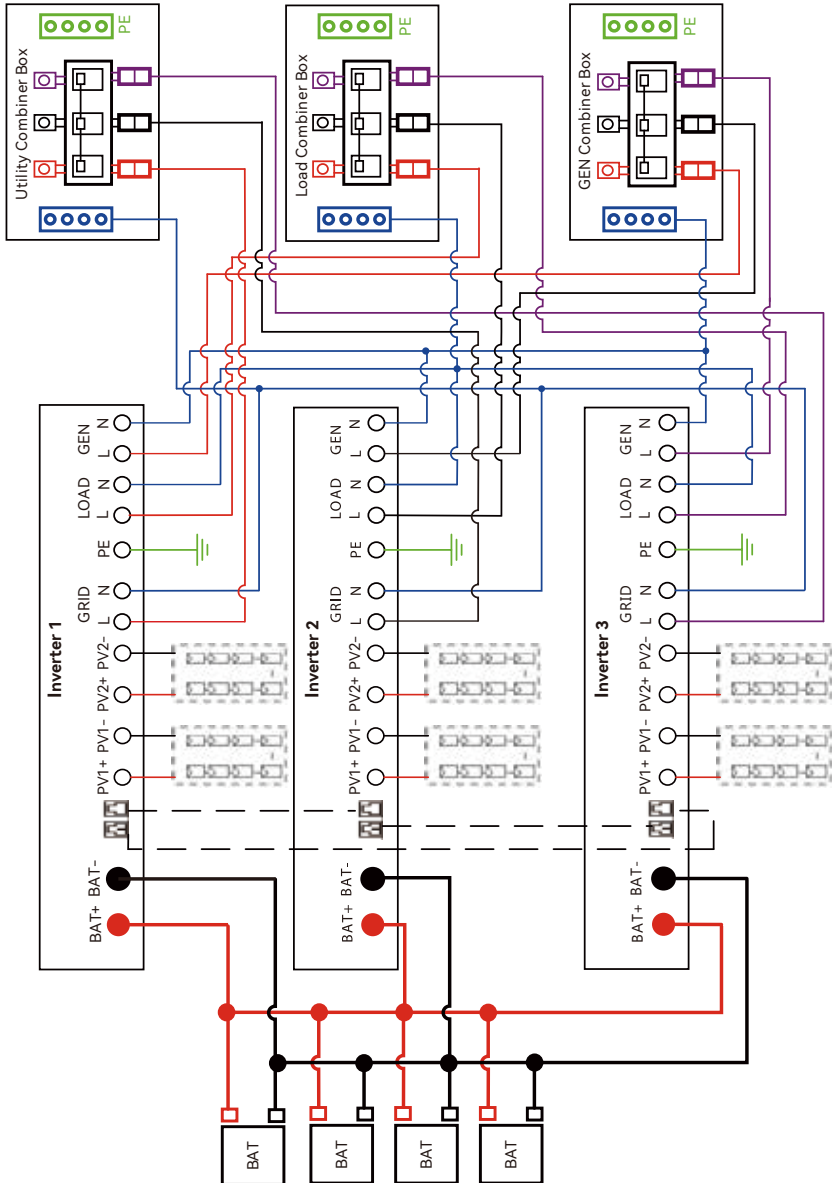

Step 2. Cable connection: the system connection is as below:

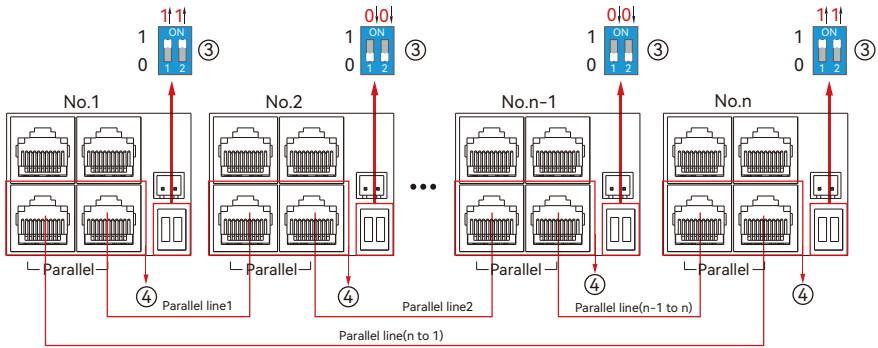

The max parallel quantity is 18, so $2 \leq n \leq 18$

Step 3. Setup the monitor for the system, add all datalogs in one station. Users can login to the visit interface of monitor system, Configuration->station->Plant Management->add datalog to add the datalogs.

Plant name	Installer	End User	Country	Timezone	Daylight saving time	Create date	Action
1 Genesis		Aspergo Install	South Africa	GMT+2	No	2019-03-14	Station Management
2 Butler Home	Elangeni	johnbutler	South Africa	GMT+2	No	2019-03-25	Station Management
3 Office			South Africa	GMT+2	No	2019-06-03	Station Management
4 Cronje Home	Broomhead	cronje	South Africa	GMT+2	No	2019-07-16	Station Management

Step 4. Enable share battery for the system if the system share one battery bank, otherwise disable the shared battery function.

Step 5. Set the system as a parallel group in the monitor system.

Serial number	Status	Solar Power	Charge Power	Discharge Power	Load	Solar Yield	Battery Dischar	Feed Energy	ConsumptionEr	Station name	Parallel	Action
1	Normal	228 W	42 W	0 W	182 W	215.3 kWh	39.6 kWh	0 kWh	551.2 kWh	Dragonview	A-1	Parallel
2		35 W	32 W	0 W	0 W	158.7 kWh	21.1 kWh	0 kWh	160.5 kWh	Dragonview	A-2	Parallel
3		1 kW	129 W	0 W	1 kW	170.3 kWh	49.9 kWh	0 kWh	434.5 kWh	Dragonview	A-3	Parallel
4		79 W	48 W	0 W	106 W	99 kWh	85.6 kWh	0 kWh	257.1 kWh	Dragonview	A-4	Parallel

For more detailed guidance for paralleling system, please visit <https://www.luxpowertek.com/download/> And download the guidance.

2.11 Power and EPS ON/OFF

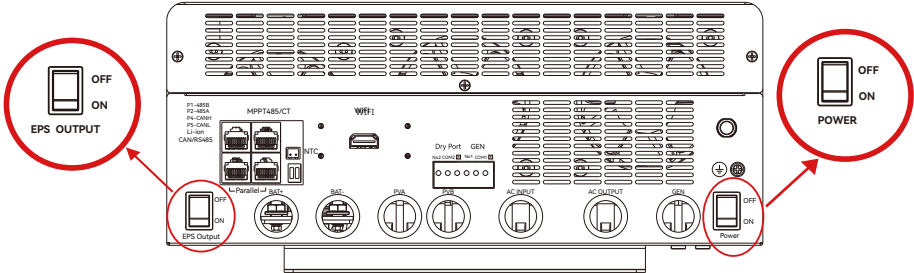









1. Power Switch: Control power supply for the unit
2. EPS Output Switch: Use to control the AC output

After connection, please turn on both switch. Users can turn off the EPS output switch to turn off power supply in some emergency case.

3. Working modes

3.1 SNA Series inverter modes introduction:

<p>Bypass Mode</p>		<p>AC is used to take the load.</p>
<p>PV Charge Bypass</p>		<p>PV charge the battery while the AC power the load.</p>
<p>BAT Grid off</p>		<p>Battery is used to take the load.</p>
<p>PV+BAT Grid off</p>		<p>PV+Battery power the load together.</p>

<p>PV Charge</p>		<p>1. When the EPS key off, the inverter charge the battery only. 2. When the battery is power off, the PV can wake up the battery automatically.</p>
<p>PV Charge+Grid off</p>		<p>PV charge the battery and power the load.</p>
<p>AC Charge</p>		<p>1. AC charge the battery from AC Input or GEN Input. 2. When the battery is power off, the AC can wake up the battery automatically</p>
<p>PV+AC charge</p>		<p>PV+AC charge the battery. AC is from AC Input or GEN Input.</p>
<p>PV Grid off</p>		<p>NOTE: The output power depends on the PV energy input, if the PV energy is unstable, witch will influence the output power.</p>
		<p>When you power off the battery, the PV will supply power to the load.</p>
<p>PV charge Grid on</p>		<p>PV charge battery and power the load. *The rest power from PV can feed in Grid.</p>
<p>PV+BAT Grid on</p>		<p>PV+Battery power the load, and the AC can power the load if PV+Battery power not enough.</p>
<p>PV Grid on</p>		<p>PV power the load, the rest power feed in Grid.</p>

3.2 Working Modes related setting description

Situation	Setting 1	Setting 2	Setting 3	Working modes and Description
AC abnormal	NA	NA	NA	off grid inverter mode if P_Solar>=P_load, solar is used to take load and charge battery if P_Solar<P_load, solar and battery take the load together, system will discharge until battery lower than the Cut Off Voltage / SOC.
		In the AC first time	NA	Hybrid Mode 1(charge first) Solar power will used to charge battery first, The solar power will be used to charge the battery first. AC will take load. 1. 2. if solar power is higher than power need to charge the battery, the extra power will be used to take load together with grid. 3. if there is still more energy after charge battery and take the load, it will feed energy into grid if export to grid function is enabled.
	PV&AC Take Load Jointly Enable	Enable AC charge and in the AC charge time	AC charge according to Time AC charge according to battery voltage or SOC	Hybrid Mode 1(charge first)+AC charge battery if solar power is not enough to charge battery.
AC normal		Not in the AC first time and disable AC charge or not in the AC charge time	NA	Hybrid Mode 1(charge first)+AC charge battery if solar power is not enough to charge battery and the battery voltage / SOC is lower than AC start charge voltage / SOC, the AC will stop charging when the battery Voltage / SOC is higher than AC end charge battery voltage / SOC. Hybrid Mode 2(load first) Solar power will used to take load first, 1. if solar power is lower than load, battery will discharge together to take load until battery lower than EOD voltage / SOC. if solar power is higher than load, the extra power will used to charge battery, if there is still 2. more energy, it will feed into grid if enable export.
		In the AC first time	NA	Bypass Mode AC will take the load and Solar is used to charge battery.
		Enable AC charge and in the AC charge time	AC charge according to Time AC charge according to SOC / Battery voltage	Bypass Mode+AC charge battery / Solar is used to charge battery. AC will take load and also charge battery during AC charge time if solar power is not enough. Bypass Mode+AC charge battery Solar is used to charge battery. AC will take load and also charge battery when battery SOC/Voltage is lower than start SOC / Voltage, and the AC will stop charging when the battery Voltage/SOC is higher than AC end charge battery voltage / SOC.
	PV&AC Take Load Jointly Disable	Not in the AC first time and disable AC charge or not in the AC charge time	NA	off grid inverter mode if P_Solar>=P_load, solar is used to take load and charge battery if P_Solar<P_load, solar and battery take the load together, system will discharge until battery lower than EOD Voltage / SOC.

3.3 Working as a hybrid inverter

3.3.1 SNA series can work as traditional off grid inverter or as a hybrid inverter. When PV&AC Take Load Jointly function is disabled, it works as a traditional off-grid inverter; In this situation, inverter either use (solar+battery) to take load or use AC take load. otherwise, it will work in hybrid mode.

Related setting

Hybrid Setting

PV&AC Take Load Jointly

Grid CT Connection

Export to Grid

CT Power Offset(W)

Export Power Percent(%)

3.3.2 AC First: During the setting time, system will use AC to take load, use solar power to charge the battery first. If there is extra solar power, extra solar power will take the load. When out of the setting time, system will use solar and battery to take load first until battery voltage / SOC is lower than On Grid EOD settings, then it will use AC to take the load.

Start	End
<div style="display: flex; align-items: center; gap: 5px;"> <div style="background-color: #28a745; color: white; border-radius: 50%; width: 20px; height: 20px; display: flex; align-items: center; justify-content: center; font-size: 10px;">T1</div> <input style="width: 60px; text-align: center;" type="text" value="[0,23]"/> : <input style="width: 60px; text-align: center;" type="text" value="[0,23]"/> <input type="button" value="Set"/> </div>	<div style="display: flex; align-items: center; gap: 5px;"> <div style="width: 20px; height: 10px; background: linear-gradient(to right, green 50%, gray 50%);"></div> <input style="width: 60px; text-align: center;" type="text" value="[0,23]"/> : <input style="width: 60px; text-align: center;" type="text" value="[0,23]"/> <input type="button" value="Set"/> </div>
<div style="display: flex; align-items: center; gap: 5px;"> <div style="background-color: #17a2b8; color: white; border-radius: 50%; width: 20px; height: 20px; display: flex; align-items: center; justify-content: center; font-size: 10px;">T2</div> <input style="width: 60px; text-align: center;" type="text" value="[0,23]"/> : <input style="width: 60px; text-align: center;" type="text" value="[0,23]"/> <input type="button" value="Set"/> </div>	<div style="display: flex; align-items: center; gap: 5px;"> <div style="width: 20px; height: 10px; background: linear-gradient(to right, green 50%, gray 50%);"></div> <input style="width: 60px; text-align: center;" type="text" value="[0,23]"/> : <input style="width: 60px; text-align: center;" type="text" value="[0,23]"/> <input type="button" value="Set"/> </div>
<div style="display: flex; align-items: center; gap: 5px;"> <div style="background-color: #17a2b8; color: white; border-radius: 50%; width: 20px; height: 20px; display: flex; align-items: center; justify-content: center; font-size: 10px;">T3</div> <input style="width: 60px; text-align: center;" type="text" value="[0,23]"/> : <input style="width: 60px; text-align: center;" type="text" value="[0,23]"/> <input type="button" value="Set"/> </div>	<div style="display: flex; align-items: center; gap: 5px;"> <div style="width: 20px; height: 10px; background: linear-gradient(to right, green 50%, gray 50%);"></div> <input style="width: 60px; text-align: center;" type="text" value="[0,23]"/> : <input style="width: 60px; text-align: center;" type="text" value="[0,23]"/> <input type="button" value="Set"/> </div>

Discharging

Discharge Control

Discharge Current Limit(Adc)

Battery Warning Voltage(V)

Battery Warning SOC(%)

On-grid CutOff SOC(%)

Off-grid CutOff SOC(%)

On-grid Cut-Off Volt(V)

Off-grid Cut-Off Volt(V)

3.3.3 AC Charge function Disable: The system will not use AC to charge the battery (except Li ion BMS set force charge flag).

AC Charge Battery Current(A)

AC Charge Based On

<Empty>

Disable

Time(According to)

Battery Voltage(According to)

Battery SOC(According to)

Battery Voltage and Time(According to)

Battery SOC and Time(According to)

- According to Time: During the setting time, system will use AC to charge the battery until battery full and battery will not discharge during the setting time.
- According to Battery Voltage: During the setting voltage, system will use AC to charge the battery if battery voltage is lower than AC Charge Start Battery Voltage and will stop when Voltage is higher than AC Charge End Battery Voltage.
- According to Battery SOC: During the setting SOC, system will use AC to charge the battery if battery SOC is lower than AC Charge Start Battery SOC and will stop when Voltage is higher than AC Charge End Battery SOC.
- According to Battery Voltage and Time: During the setting time, system will use AC to charge the battery if battery voltage is lower than AC Charge Start Battery Voltage and will stop when Voltage is higher than AC Charge End Battery Voltage. And battery will not discharge during the setting time.
- According to Battery SOC and Time: During the setting time, system will use AC to charge the battery if battery SOC is lower than AC Charge Start Battery SOC and will stop when Voltage is higher than AC Charge End Battery SOC. And battery will not discharge during the setting time.

4. LCD display and settings

4.1 LED Display

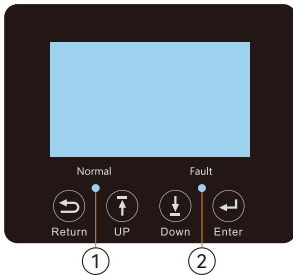

LED Indicator			Messages
1	Green	Solid On	Working normal
		Flashing	fast: Warning slow: Firmware update
2	Red	Flashing	Fault condition occurs in the inverter

4.2 LCD Display

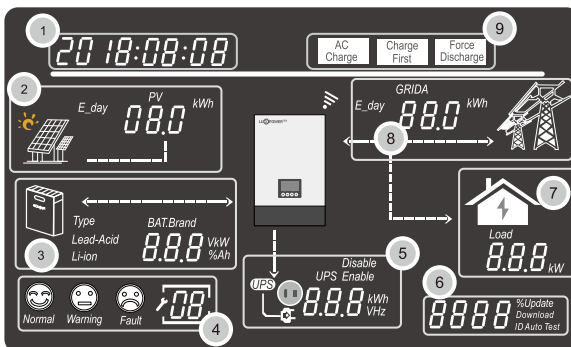

NO.	Description	Remarks
1	Generally Information Display Area	Display the currently time / date by default (year / month / day / hour / minute" switching automatically). When press Up or Down buttons, this area will display the firmware version information, serial number etc. Display the setting selection information when entering settings.
2	On-grid solar inverter output power and energy data	This area shows the data of PV voltage, power and the setting of PV input connection information.
3	Battery information and data	This area shows the battery type, battery brand (lithium battery), the lead-Acid battery setting of CV voltage, Floating charging voltage, Cut off voltage, Discharge end voltage . And display the voltage, SOC and power in turns of period of 1 seconds.
4	System working status / setting code	There are three type of working status-normal, warning and fault, in right side of this area, there are code display, it will display different type of code-the system working mode code, warning code, fault code and setting code.
5	UPS/EPS output information and data	When UPS function is enabled, this area will display UPS voltage, frequency, power etc. in turns of periods of 1s.
6	Programming & the percentage of AC output power	When firmware updating in process, it will display relevant information When in grid off, this area will display the Percentage of the maximum AC output power.
7	Loads consumption	Display the power consumption by the loads in on grid model.
8	Grid information and Generator information	Display the grid (GRIDA) information of voltage, frequency, input or output power, the Generator (GRIDB) information of voltage, frequency, input power ,switch period of 1s.
9	Working mode settings area	When make settings on the SNA series inverter through the LCD, this area will display the AC Charge, Force Discharge, Charge First option for setting on those working modes. It will not display those information unless in the setting process.

4.3 Inverter Status Display

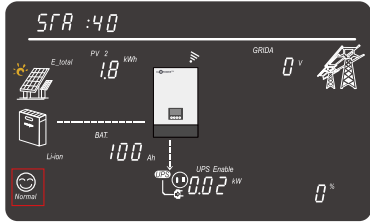
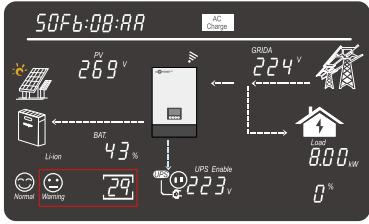
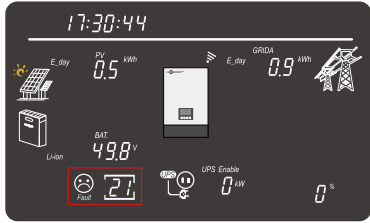
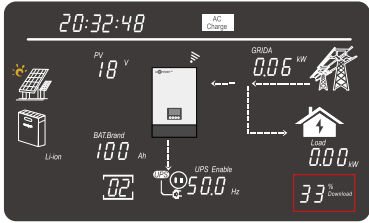
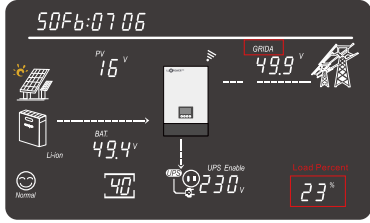
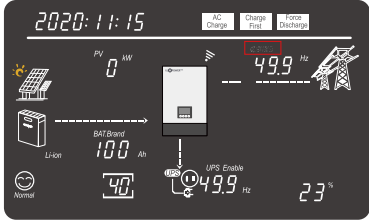
<p>Normal status, running status 40</p> 	<p>Warning Status, warning 29</p> 
<p>Fault status, fault 21</p> 	<p>Flash status: download percent is 33%</p> 
<p>When display 'GRIDA', it means the Grid information is about AC utility, The percent display on the right down corner means the load percentage.</p> 	<p>When display 'GRIDB', it means the AC information is about Gen set input.</p> 

4.4 LCD Settings

There are four buttons on the LCD.

Return

UP





Down



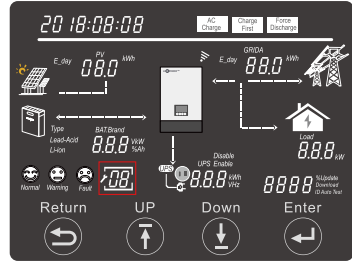

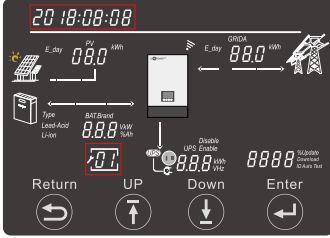
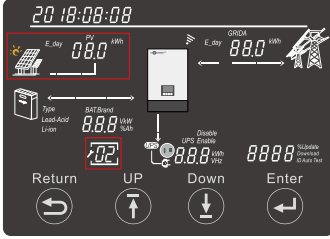

Enter

Step for setting by the display:

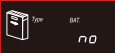

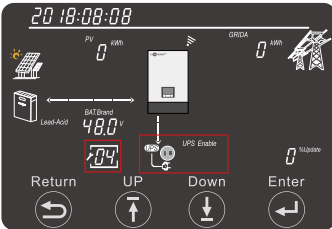

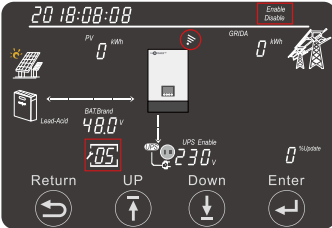
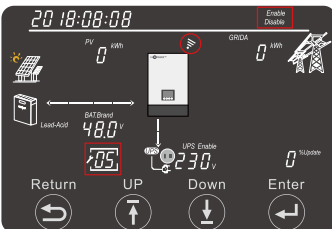

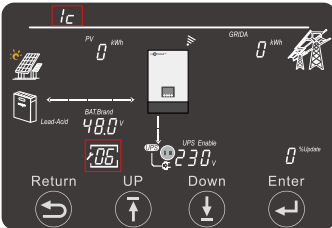
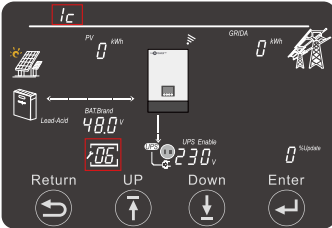
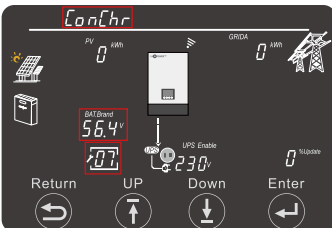

- Step 1.** After touch Enter button for about 2 seconds, the unit will enter setting mode. The setting icon and index will flashing.
- Step 2.** Touch UP or Down button to select setting index form 1 to 19.
- Step 3.** Then touch Enter button to set this item.
- Step 4.** Touch UP or Down button to change the settings.
- Step 5.** Touch Enter to confirm the setting or Return the setting list is as below.

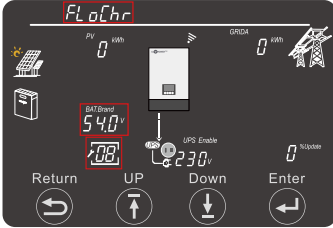

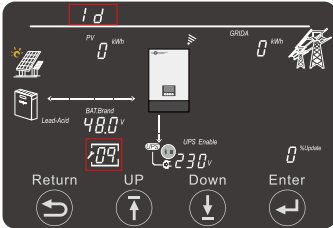

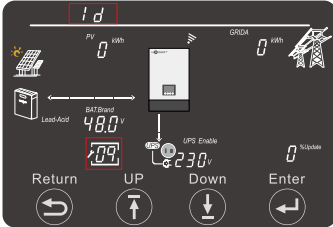

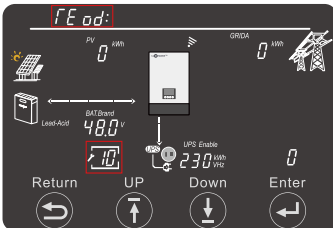
Index	Description	Setting Option
1	Date&time	<div style="display: flex; align-items: center;">  <div style="margin-left: 20px;"> <p>Setting Year / Month / day</p> <div style="border: 1px solid black; padding: 2px; display: inline-block; margin-bottom: 10px;">20 18:08:08</div> <p>Setting hour / minute / second</p> <div style="border: 1px solid black; padding: 2px; display: inline-block;">18:09:08</div> </div> </div>
2	PV input mode	<div style="display: flex; align-items: center;">  <div style="margin-left: 20px;"> <p>Default: S S: two independent Strings input</p> <div style="border: 1px solid black; padding: 2px; display: inline-block; margin-bottom: 10px;">  5 </div> <p>P: Same string input for 2 MPPTs</p> <div style="border: 1px solid black; padding: 2px; display: inline-block; margin-bottom: 10px;">  P </div> <p>dc: DC source input</p> <div style="border: 1px solid black; padding: 2px; display: inline-block;">  dc </div> </div> </div>

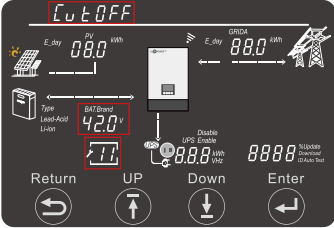
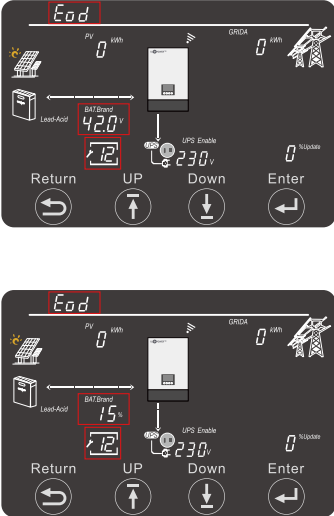
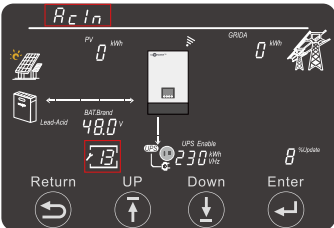

<p>3</p>	<p>Battery</p>	<p>Run with No Battery: Step 1. Choose battery type first, when no flashing, select Enter to choose Run with No battery.</p>  <p>For Lead Acid: Step 1. Choose battery type first, when Lead-Acid flashing, select Enter to choose Lead-acid battery. Step 2. Then choose battery capacity.</p>  <p>For Lithium battery: Step 1. Choose battery type first, when Li-ion flashing, select Enter to choose Li-ion battery Step 2. Choose battery brand. 0- > Standard Battery 2->Pylon Battery 6->Luxpower protocol Battery 8->Dyness Battery</p> 
<p>4</p>	<p>UPS Output voltage and frequency</p>	 <p>AC Output voltage 200Vac / 208Vac / 220Vac / 230Vac (Default) / 240Vac</p>  <p>AC Output frequency 50Hz (Default)/60Hz</p> 
<p>5</p>	<p>Buzzer enable</p>	 <p>Buzzer enable (Default)</p>  <p>Buzzer Disable</p> 

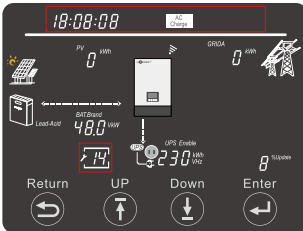
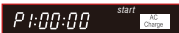
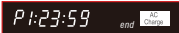
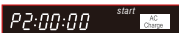
<p>6</p>	<p>Ic: Maximum charge current</p>	<p>MODEL: SNA5000WPV</p>  <p>Totoal charge current (Iac+Ipv) setting Setting range: 0A~110A Default: 110A</p> <p>Ic: 110A</p> <p>AC charge current setting: Setting range: 0A~110A Default: 30A</p> <p>I2c: 30A</p> <p>Generator charge current setting: Setting range: 0A~60A Default: 30A</p> <p>I3c: 30A</p> <hr/> <p>MODEL: SNA6000WPV</p>  <p>Totoal charge current (Iac+Ipv) setting Setting range: 0A~140A Default: 140A</p> <p>Ic: 140A</p> <p>AC charge current setting: Setting range: 0A~140A Default: 30A</p> <p>I2c: 30A</p> <p>Generator charge current setting: Setting range: 0A~110A Default: 30A</p> <p>I3c: 30A</p>
<p>7</p>	<p>ConChr: CV voltage setting (Only in Lead-acid battery type)</p>	 <p>Setting range: 50.0~59.0Vdc Default: 56.4V</p> <p>ConChr: 56.4V</p>

<p>8</p>	<p>FloChr: Floating charging voltage setting (Only in Lead-acid battery type)</p>		<p>Setting range: 50.0~56.0Vdc Default: 54.0V</p> 
<p>9</p>	<p>Id: Maximum discharge current</p>	<p>MODEL: SNA5000WPV</p> 	<p>Total discharge current setting Setting range: 0A~110A Default: 110A</p> 
		<p>MODEL: SNA6000WPV</p> 	<p>Total discharge current setting Setting range: 0A~140A Default: 140A</p> 
<p>10</p>	<p>TEOd: Discharge control type: VOLT / SOC</p>		<p>Setting Range: VOLT / SOC</p> 

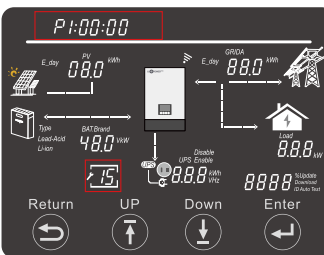
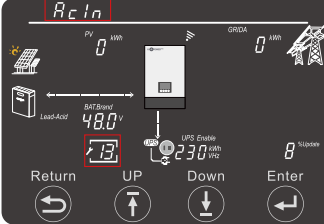

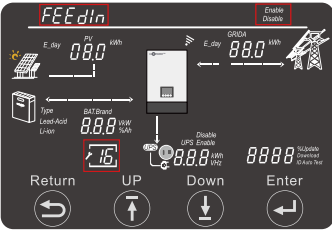
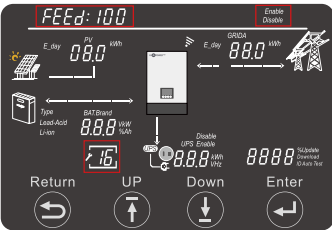

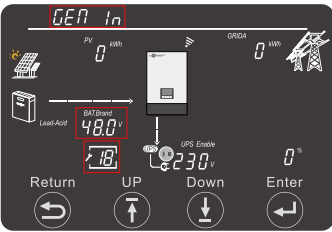

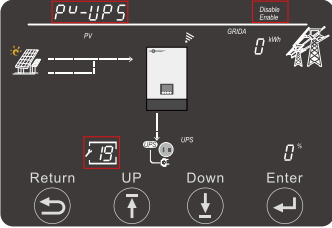
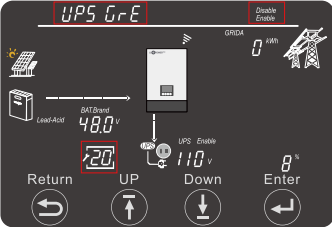
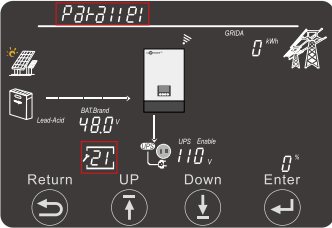

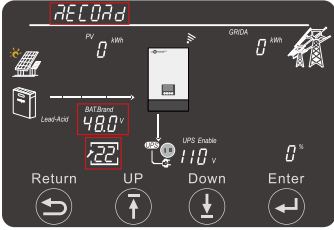
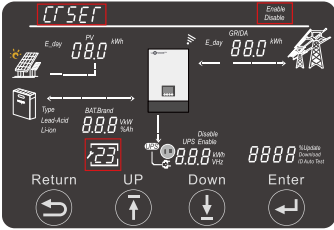
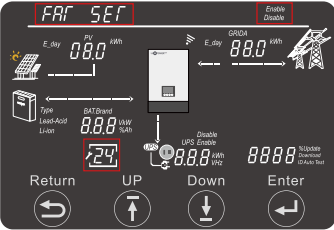
<p>11</p>	<p>CutOFF: Cut off Voltage or SOC, depend on TEOD</p>		<p>Setting range: VOLT: 40.0-OnGrid EOD Volt Default:42V</p> <p>SOC: 0-OnGrid EOD SOC Default: 15%</p>
<p>12</p>	<p>Eod: Discharge end voltage or soc with grid, depend on TEOD</p>		<p>Setting range: VOLT: Cut off Volt-58V Default: 42V</p> <p>SOC: Cut off SOC-90 Default: 15%</p>
<p>13</p>	<p>AcIn: AC voltage range setting</p>		<p>Unity AC Input voltage range: 90Vac~280Vac</p> <p>Unity AC Input voltage range: 170Vac~280Vac</p>

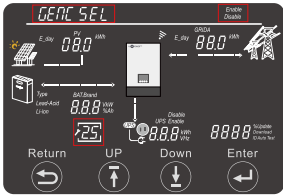

	<p>AC charge setting (The setting process must enable the AC charging function, confirm the full battery SOC value, and set the confirmation time period 1, 2, 3 to truly complete the AC charging function setting)</p>		<p>AC Charge function: Setting range: 1. DIS: AC charge disable; 2. TIM: According to time; 3. VOL: According to battery voltage; 4. SOC: According to battery soc; (Touch "Enter" button to set ac charge parameter)</p> <p>AcCh: d 15</p>
<p>14</p>	<p>AC charge control: Setting range: Vol: 1. Start Voltage: 35.4~52V; 2. End Voltage: 48~59V; SOC: 1. Start Soc: 1~90%; 2. End Soc: 20~100%;</p>	  <p>Setting AC Charge time of 1 start: Range: 00:00~23:59 Default: 00:00~00:00</p> <p>Setting AC Charge time of 1 end: Range: 00:00~23:59 Default: 00:00~00:00</p> <p>Similar to set time2 and times</p>  	 
<p>15</p>	<p>Utility source (AC Input) to take Load time setting</p>		<p>Setting time of 1 start: Range: 00:00~23:59 Default: 00:00~00:00</p> <p>Setting time of 1 end: Range: 00:00~23:59 Default: 00:00~00:00</p> <p>Similar to set time2 and time3</p>
<p>16</p>	<p>Hybrid enable / disable</p>		<p>Setting Range: Hybrid Disable (default)</p> <p>Disable</p> <p>Hybrid Enable</p> <p>Enable</p>

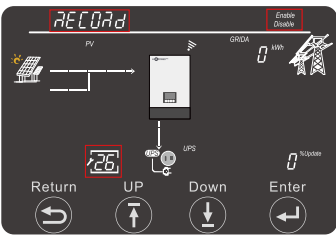
	<p>Feed-In Enable / disable Only valid when Hybrid is enabled</p>		<p>Setting Range: Feed-In Disable (default)</p> <p>Disable</p> <p>Feed-In Enable</p> <p>Enable</p>
<p>16</p>	<p>Maximum Feed-In percent Only valid when Feed-In is enabled Power percent can be set larger than 100% in case of there is other generating device in the system</p>		<p>Setting Range: 0-100% 0% (default)</p> <p>FEED: 100</p>
<p>17</p>	<p>Battery Wakeup Enable / disable (Not for No Battery type)</p>		<p>Enable wakeup battery</p> 
<p>18</p>	<p>Max Generator Input Power</p>		<p>Setting Range: 0-7369W 7369W (default)</p> <p>GEN: 7369^{POWER}</p>

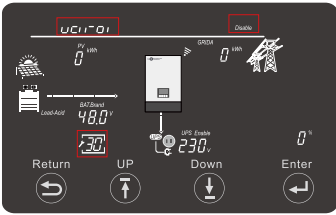
<p>19</p>	<p>PV Off Grid enable / disable</p>		<p>Setting Range: PV Off Grid Enable (default)</p> <p>Enable</p> <p>PV Off Grid Disable</p> <p>Disable</p>
<p>20</p>	<p>Power Save Function enable / disable</p>	 <p>Setting Range: ECO Mode Disable (default) ECO Mode Enable</p> <p>Disable Enable Enable</p>	<p>Setting Range: Green Function Disable (default)</p> <p>Disable</p> <p>Green Function Enable: When enabled, if the inverter load reading is less than 60W for more than 0minutes, the inverter output will be cut off.</p>
<p>21</p>	<p>Parallel setting</p>	 <p>Parallel phase setting Setting Range: P1 (Rphase) / P2 (Sphase) / P3 (Tphase) P1 (default)</p> <p>PHAS: P1</p>	<p>Parallel type setting Setting Range: NoPL (not Parallel) / 1PH (Single phase) / 3PH (Three phase) NoPL (default)</p> <p>P3P: 1PH</p> <p>Bat Share enable / disable Setting Range: Disable (default) Enable</p> <p>BatShare Disable Enable</p>

<p>22</p>	<p>Error / Alarm Record</p>		<p>Error Record ->Record Index ->>Record Msg: (Year: Month: Day; Hour: Min:Sec; Error code)</p> <p>Err REC</p> <p>Alarm Record->Record Index->>Record Msg: (Year: Month:Day; Hour: Min: Sec; Alarm code)</p> <p>ALB REC</p>
<p>23</p>	<p>CT Offset</p>		<p>External Grid CT (Latest Version Only) Setting Range: Disable (default) / Enable</p> <p>CT-EX <input type="button" value="Disable"/> <input type="button" value="Enable"/></p> <p>Internal CT Offset Setting Range: ~200~200W 20W (default)</p> <p>CT <input type="button" value="Power"/> -169</p>
<p>24</p>	<p>Fan speed setting</p>	 <p>Fan2 Speed Percent Setting Range: 20-100% 70% (default)</p> <p>FAN : 055</p> <p>Fan1 Speed New Slope Setting Range: Disable (default) Enable</p> <p>FAN SL OP <input type="button" value="Enable"/> <input type="button" value="Disable"/></p>	<p>Fan1 Speed Percent Setting Range: 20-100% 70% (default)</p> <p>FAN : 055</p> <p>Fan1 Speed New Slope Setting Range: Disable (default) Enable</p> <p>FAN SL OP <input type="button" value="Enable"/> <input type="button" value="Disable"/></p>

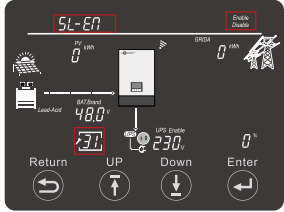
<p>25</p>	<p>Generator charge setting</p>	 <p>Generator charge setting ->charge control type Setting Range: 1. VOL (default) 2. SOC</p>  <p>->control type ->>control value Setting Range: VOL : 1. Start Voltage: 38.4-52V; 2. End Voltage: 48-59V; SOC: 1. Start Soc: 1-90%; 2. End Soc: 20-100%;</p>  
<p>26</p>	<p>Neutral-Ground Bonding Function</p>	 <p>This setting allows the user to enable or disable the internal neutral-ground bond. The inverter must be in standby to make this change. Turn the “EPS Output” switch to off to engage standby mode. Range: Enable / Disable Default: Enable</p> 
<p>30</p>	<p>GEN BOOST Enable/Disable</p>	 <p>GEN BOOST ->Enable/Disable Setting Range: 1. Disable (default) 2. Enable</p> 

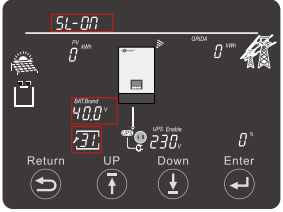
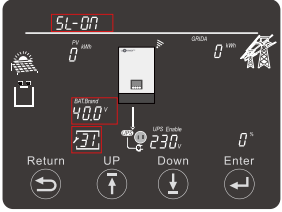
		
		<p>Smart Load ->Enable/Disable Setting Range: 1. Disable (default) 2. Enable</p> <div style="display: flex; justify-content: space-around; align-items: center;"> <div style="border: 1px solid black; padding: 5px; background-color: black; color: white; font-weight: bold;">Enable</div> <div style="border: 1px solid black; padding: 5px; background-color: black; color: white; font-weight: bold;">Disable</div> </div>
		<p>-->>Smart Load GridOn Setting Range: 1. Disable (default) 2. Enable</p> <div style="border: 1px solid black; padding: 5px; background-color: black; color: white; text-align: center; font-weight: bold;">SL-GR 1d</div>
<p>31</p>	<p>Smart Load Enable/Disable</p>	<p>-->>>Smart Load PV Power Setting Range: 0-25.5kW; (0.5kW default)</p> 
		<p>-->>>>Smart Load On Volt/Soc Setting Range: VOL: 40~59V; (54V default) SOC: 0~100%; (90% default)</p>  

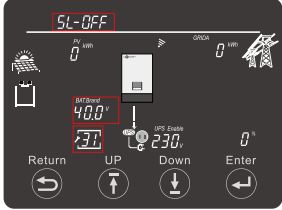
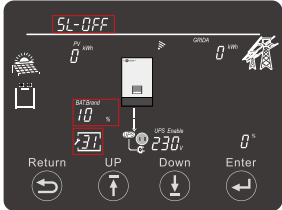
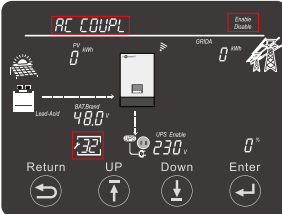
		<p>->>>>>Smart Load Off Volt/Soc Setting Range: VOL: 40~59V; (48V default) SOC: 0~100%; (60% default)</p>  
<p>32</p>	<p>AC Couple Enable/Disable</p>	 <div style="display: flex; justify-content: space-around; margin: 20px 0;"> <div style="border: 2px solid black; padding: 5px 15px; background-color: #f0f0f0;">Enable</div> <div style="border: 2px solid black; padding: 5px 15px; background-color: #f0f0f0;">Disable</div> </div> <p>AC Couple ->Enable/Disable Setting Range: 1. Disable (default) 2. Enable</p>

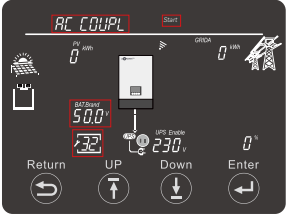
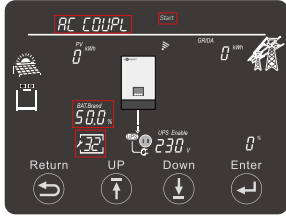
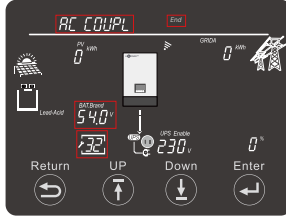
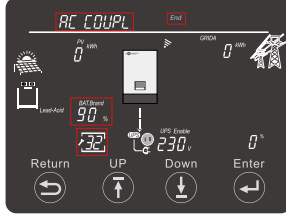
		<p>->> AC couple Start Volt/Soc Setting Range: VOL: 40~59V; (50V default) SOC: 0~101%; (50% default)</p>  
		<p>->>> AC couple End Volt/Soc Setting Range: VOL: 40~59V; (54V default) SOC: 0~101%; (90% default)</p>  

5. Monitor System for SNA Series inverter

- Users can use wifi dongle / WLAN dongle / 4G dongle (Available from 2021 March for some countries) to monitor the energy storage system, The monitor website is: server.luxpowertek.com
- The APP is also available in the google play and apple APP store (Scan two code bar to download the APP).
- Please download the introduction of guidance by website: <https://www.luxpowertek.com/download/> Document Reference.

1. Wifi Quick Guidance

Quick guidance for setting password for wifi module, the paper is also available in the wifi box.

2. Monitor system setup for Distributors and Monitor system setup for endusers, Monitor system registration, wifi password setting, and wifi local monitor and setting.

3. Lux_Monitor_UI_Introduction

Introduction of monitor interface

4. Website Setting Guidance

Introduction of website settings for offgrid inverter

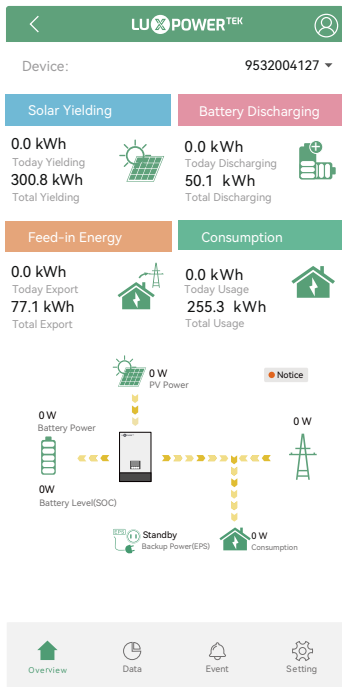

6. Specifications

Table 1 MPPT Mode Specifications		
INVERTER MODEL	SNA5000WPV	SNA6000WPV
Max. PV Array Power(W)	8000(4000/4000)	
Rated PV Input Voltage(V)	320	
Number of Independent MPPT Inputs	2	
PV Input Voltage Range(V)	100~480	
MPPT Voltage Range(V)	120~385	
Start-up Voltage(V)	100	
Max. PV Input Current per MPPT (A)	17/17	
Max. PV Short-circuit Current per MPPT(A)	25/25	
Max. PV Charging Current(A)	110	140
Table 2 Battery Mode Specifications		
INVERTER MODEL	SNA5000WPV	SNA6000WPV
Output Voltage Waveform	Pure Sine Wave	
Output Voltage Regulation	208Vac / 220Vac / 230Vac / 240Vac±5%	
Output Frequency	50Hz / 60Hz	
Rated Output Power(W)	5000	6000
Rated Output Current(A)	22	26.5
Max. Charging / Discharging Current(A)	110/110	140/140
Max. Charging / Discharging Power(W)	5000	6000
Peak Efficiency	93%	
Overload Protection	5s@≥150% load; 10s@110%~150% load	
Surge Capacity	2* rated power within 5 seconds	
Recommend Capacity of Battery per Inverter	>200AH	
Battery Voltage Range	46.4V-60V(Li)	38.4V-60V(Lead_Acid)
High DC Cut-off Voltage	59VDC(Li)	60VDC(Lead_Acid)
High DC Recovery Voltage	57.4VDC(Li)	58VDC(Lead_Acid)

Low DC Warning Voltage(Lead Acid)	load < 20%	44.0Vdc(Settable)
	20% ≤ load < 50%	Warning Voltage@load < 20% -1.2V
	load ≥ 50%	Warning Voltage@load < 20% -3.6V
Low DC Warning Return Voltage(Lead Acid)		Low DC Warning Voltage@Different load+2V
Low DC Cut-off Voltage(Lead Acid)	load < 20%	42.0Vdc(Settable)
	20% ≤ load < 50%	Cut-off Voltage@load < 20% -1.2V
	load ≥ 50%	Cut-off Voltage@load < 20% -3.6V
Low DC Cut-off Return Voltage(Lead Acid)	Cut-off Voltage@load<20%≥45V	Low DC Cut-off Voltage@load<20%+3V
	Cut-off Voltage@load<20%<45V	48V
Low DC Warning SOC		20% SOC(Settable)
Low DC Warning Return SOC		Low DC Warning SOC +10%
Low DC Cut-off SOC		15% SOC (Grid on) (settable)
		15% SOC (Grid off) (settable)
Low DC Cut-off Return SOC		Low DC Cut-off SOC +10%
Charge Cut-off Voltage		58.4Vdc
No Load Power Consumption		<60W
Lead_Acid Battery Charging Algorithm		3-Step
Bulk Charging Voltage		Flooded Battery 58.4Vdc
		AGM / Gel Battery 56.4Vdc
Floating Charging Voltage		54Vdc

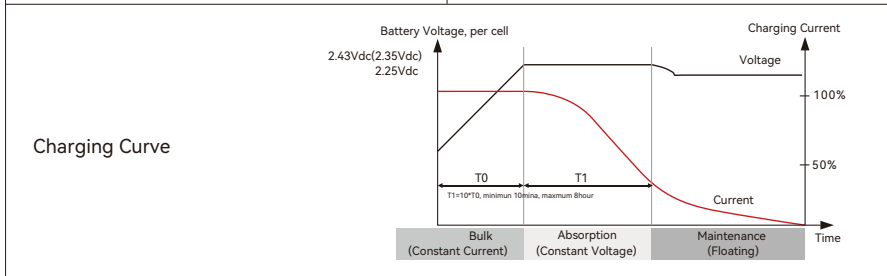

Table 3 Line Mode Specifications

Table 3 Line Mode Specifications		
INVERTER MODEL	SNA5000WPV	SNA6000WPV
Input Voltage Waveform	Sinusoidal(utility or generator)	
Nominal Input Voltage(V)	230Vac	
Low Loss Voltage	170Vac±7V(UPS); 90Vac±7V(Appliances)	
Low Loss Return Voltage	180Vac±7V(UPS); 100Vac±7V(Appliances)	
High Loss Voltage	280Vac±7V	
High Loss Return Voltage	270Vac±7V	
Max. AC Input Voltage	280Vac	
Nominal Input Frequency	50Hz/60Hz(Auto detection)	
Max. AC Input Current(A)	35	39.5
Max. AC Input Power(W)	8000	9000
Max. AC Charging Current(A)	110	140
Rated AC Output Current(A)	22	26.5
Rated AC Output Power(W)	5000	6000
Rated AC Current of Bypass Relays(A)	40	60
Output Short Circuit Protection	Software Protect when GridOff Discharge Circuit Breaker Protect when GridOn Bypass	
Transfer Time	<15ms@Single ; <30ms@Parallel	
Output power derating: When AC input voltage drops to 200V, the output power will be derated.	Max inv current: 25A Max inv power: 5kW	Max inv current: 30A Max inv power: 6kW

Table 4 Generator Mode Specifications		
INVERTER MODEL	SNA5000WPV	SNA6000WPV
Rated GEN Voltage(V)	230	
Rated GEN Frequency(Hz)	50/60	
Rated GEN Input Current(A)	32	
Rated GEN Input Power(W)	7370	
Rated GEN Current of Bypass Relays(A)	40	60
Table 5 Protection/General Specifications		
INVERTER MODEL	SNA5000WPV	SNA6000WPV
Over Current / Voltage Protection	YES	
Grid Monitoring	YES	
AC Surge Protection Type III	YES	
Safety Certification	NRS 097, CE	
Ingress Protection Rating	IP 20	
Display&Communication Interface	LCD+LED, RS485 / WIFI / CAN	
Warranty	2 Years	
Cooling Method	FAN	
Topology	Transformer-less	
Noise Emission(typical)	<50dB	
Operating Temperature Range	0°C to 45°C(full load)	
Storage temperature	-15°C ~ 60°C	
Humidity	5% to 95% Relative Humidity(Non-condensing)	
Altitude	<2000m	
Dimension(D*W*H)mm	505*330*135mm	
Net Weight	14.5kg	

7. Trouble Shooting & Error List

The failures mainly divided into 5 categories, for each category, the behavior is different:

Code	Description	Trouble shooting
E000	Internal communication fault1	Restart inverter, if the error still exist, contact us (DSP&M3)
E002	Bat On Mos Fail	Restart inverter, if the error still exist, contact us
E003	CT Fail	Restart inverter, if the error still exist, contact us
E008	CAN communication error in Parallel System	Check CAN cable connection is connected to the right COM por
E009	No master in parallel system	Check parallel setting for master/Slave part, there should be one master in the system
E012	UPS output short circuit	Check if the load is short circuit, try to turn off the load and restart inverter
E013	UPS reserve current	Restart inverter, if the error still exist, contact us
E015	Phase Error in three phase parallel system	Check if the AC connection is right for three phase system, there should one at least one inverter in each phase
E016	Relay fault	Restart inverter, if the error still exist, contact us
E017	Internal communication fault2	Restart inverter, if the error still exist, contact us (DSP&M8)
E018	Internal communication fault3	Restart inverter, if the error still exist, contact us (DSP&M3)
E019	Bus voltage high	Check if PV input voltage is higher than 480V
E020	EPS connection fault	Check if EPS and AC connection is in wrong terminal
E021	PV voltage high	Check PV input connection and if PV input voltage is higher than 480V
E022	Over current internal	Restart inverter, if the error still exist, contact us
E024	PV short	Check PV connection
E025	Temperature over range	The internal temperature of inverter is too high, turn off the inverter for 10minutes, restart the inverter, if the error still exist, contact us
E026	Internal Fault	Restart inverter, if the error still exist, contact us (Bus sample)
E028	Sync signal lost in parallel system	Check CAN cable connection is connected to the right COM port
E029	Sync triger signal lost in parallel system	
E031	Internal communication fault4	Restart inverter, if the error still exist, contact us (DSP&M8)

Code	Description	Trouble shooting
W000	Communication failure with battery	Check if you have choose the right battery brand and communication cable is right, if the warning still exist, contact us
W003	Communication failure with meter	Check communication cable, if the warning still exist, contact us
W004	Battery failure	Inverter get battery fault info from battery BMS, restart battery, if the warning still exist, contact us or battery manufacture
W008	Software mismatch	Please contact Luxpower for firmware update
W009	Fan Stuck	Check if the fan is OK
W012	Bat On Mos	Restart inverter, if the error still exist, contact us
W013	Over temperature	The temperature is a little bit high inside inverter
W015	Bat Reverse	Check the battery connection with inverter is right, if the warning still exist, contact us
W018	AC Frequency out of range	Check AC frequency is in range
W019	AC inconsistent in parallel system2	Reconnect the AC input or Restart inverter, if the error still exist, contact us
W025	Battery voltage high	Check if battery voltage is in normal range
W026	Battery voltage low	Check if battery voltage is in normal range, need to charge the battery if battery voltage is low
W027	Battery open	Check if there is output from the battery and battery connection with inverter is OK
W028	EPS Over load	Check if EPS load is too high
W029	EPS voltage high	Restart inverter, if the error still exist, contact us
W031	EPS DCV high	Restart inverter, if the error still exist, contact us

■ YOUR RELIABLE ENERGY SOLUTIONS PARTNER



Lux Power Technology Co., Ltd
Headquarter: +86 755 8520 9056
www.luxpowertek.com
Contact us: info@luxpowertek.com



092.20024AB