

# Your Reliable Energy Solution Partner

2024



C501, Building A, Donghua Industrial Park,  
5003 Bao'an Avenue, Sanwei Community,  
Hangcheng Street, Bao'an District,  
Shenzhen, 518126, China.



+86 0755 8520 9056  
[www.luxpowertek.com](http://www.luxpowertek.com)  
[info@luxpowertek.com](mailto:info@luxpowertek.com)

" There are over **300,000+**

Luxpower systems installed worldwide in various scenarios, including hybrid, off-grid, all-in-one ess, AC coupling and DC coupling, battery storage system.

We are dedicated to assisting our users in utilizing the energy from the sun and improving their quality of life."



Continue Expanding...



Website



LinkedIn



Facebook



YouTube

Luxpowertek



## 01 Hybrid Series

Single-Phase



GEN-LB-EU 3-6K P06



GEN-LB-EU 7-10K P08



LXP-LB-EU 12K P10

Split-Phase



LXP-LB-US 8-10K P12



LXP-LB-US 12K P14

Three-Phase



TriP 6-30K P16

## 02 Eco Hybrid/Off-grid Series

Single-Phase



SNA 3-6K P20



SNA 12K P22

Split-Phase



SNA US 6000 P25



SNA US 12K P26

## 03 AC/DC Retrofit Series



ACS 3600 P30



SQPOD 3600 P32

LSP 100K P34

## 04 All-In-One ESS Series

Single-Phase



Eco Beast P36

Split-Phase



LiteStor P38

## 05 Battery Storage Series

Low Voltage



Li-5 P42



PGEM P44



PGEM PRO P46



PSHIELD P48

High Voltage

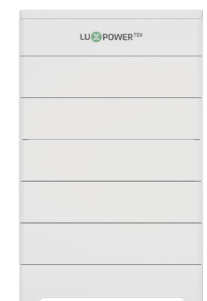

PSTACK P50

LUXPOWER<sup>TEK</sup>

# HYBRID SERIES

- Single-Phase

GEN-LB-EU 3-6K

GEN-LB-EU 7-10K

LXP-LB-EU 12K

- Split-Phase

LXP-LB-US 8-10K

LXP-LB-US 12K

- Three-Phase

TriP 6-30K

# HYBRID SERIES

## Intelligent Working Modes

- Weather compensation and smart octopus charging packages
- Self consumption mode for high tariff areas
- Charge priority mode for areas where grid power is unstable
- Force charge & discharge mode for variable tariff integration

## Smart EPS (Emergency Power Supply)

- Plug & Play integrated changeover, seamless switching under 20ms
- Auto backup power for critical load emergency supply

## Intelligent Battery Integration

- Remote upgrade for battery management system (BMS) firmware
- Wide range of compatible battery brands
- Auto 'wake-up' function of lithium battery from sleep mode
- Essential info uploaded to LUX server for quick ESS diagnosis
- Battery sharing with multi-inverters in single-phase or three-phase

## Advanced Parallel Units (Parallel Versions)

- Up to 10 units parallel
- Single-phase and unbalanced three-phase paralleling

## Key Features

- High PV input power
- High charge/discharge rates
- Light, fast & easy installation
- Free Wi-fi monitoring on mobile&PC
- Multi-phase output on different hybrid models
- Generator interface available

# HYBRID SERIES

## Single-Phase

# GEN-LB-EU 3-6K

- 2 MPPTs, Max. PV input 9kW, 18A Max.PV input current per MPPT
- Max. charge and discharge current: 125/140A
- Support up to 10pcs in parallel for on/off grid
- Time of Use and weather optimization charge for e-bill reduction
- On/off grid seamless switching
- Separate port for
  - Generator connection
    - Auto generator control
    - Support generator exercise
    - Support generator boost function
  - Or smart load connection and auto control
  - Or AC coupling function



## Specification

INPUT (PV DC)	3K	3.6K	4K	4.6K	5K	6K
Max. PV array power(W)	6600	6600	7000		9000	
Rated PV input voltage(V)				360		
Number of independent MPPT inputs				2/(1:1)		
PV input voltage range(V)				100~530		
MPPT voltage range(V)				150~425		
Start-up voltage(V)				140		
Max. PV input current per MPPT(A)				18		
Max. PV short-circuit current input per MPPT(A)				32		
<b>Battery</b>						
Compatible battery type				Lithium-ion/Lead-Acid		
Rated battery voltage(V)				48		
Battery voltage range(V)				40~60		
Max. charge/discharge current(A)	80/80	80/80	80/80	96/96	105/120	125/140
Max. charge/discharge power(W)	3000	3600	4000	4600	5000	6000
Force wake up battery from PV function				YES		
<b>Grid</b>						
Rated AC voltage(V)				230		
Rated AC frequency(Hz)				50/60		
Rated AC output current(A)	13	15.7	17.4	20	21.7	26
Rated AC output power(W)	3000	3600	4000	4600	5000	6000
Max. AC input power(W)				12000		
PF				0.99 (Adjustable from 0.8 leading to 0.8 lagging)		
THDI				<3%		
Max. continuous AC passthrough current(A)				52.2		
<b>UPS</b>						
Rated output power(W)	3000	3600	4000	4600	5000	6000
Rated output voltage(V)				230		
Rated output current(A)	13	15.7	17.4	20	21.7	26
Rated output frequency(Hz)				50/60		
Surge power, duration				2Pn, 0.5s		
Switching time(UPS)				20ms		
Wave form				Sine wave		
THDV				<5%		
<b>Efficiency</b>						
MPPT efficiency				99.9%		
Max. efficiency				97.3%		
Max. charge efficiency				94.5%		
Max. discharge efficiency				94.5%		
<b>Protection</b>						
Over current / voltage protection				YES		
Anti-islanding protection				YES		
AC Short-circuit current protection				YES		
Leakage current protection				YES		
Ground fault monitoring				YES		
Grid monitoring				YES		
DC Switch				YES		
DC Surge protection Type III				YES		
AC Surge protection Type III				YES		
<b>General</b>						
Dimensions(W*H*D)				487*455*211.7mm/19.2*17.9*8.3inch		
Weight				29kg/64lbs		
Ingress protection rating				IP65		
Operating environment temperature range(°C)				-25~60		
Storage temperature range(°C)				-40~65		
Relative humidity				0~95%		
Display & Communication interface				LCD+RGB, RS485/WI-FI/CAN		
Warranty				5 years		
Cooling method				Smart cooling		
Topology on AC side				Transformer-less		
Topology on Battery side				Transformer		
Altitude(m)				2000		
Noise emission(typical)				25db		
DC connection(VP-D4/MC4(Optional))				MC4		
AC connector				YES		
<b>Standard &amp; Certification</b>						
G99, G100, CEI 0-21, RD 1699, NTS, UNE 217001, NRS 097						



# HYBRID SERIES

## Single-Phase

# GEN-LB-EU 7-10K

- 2 MPPTs, Max. PV input 15kW
- Max. charging and discharging current: 210A
- Supports up to 10pcs in parallel for on/off grid
- Time of Use and weather optimization charge for e-bill reduction
- Separate port for
  - Generator connection
    - Auto generator control
    - Support generator exercise
    - Support generator boost function
  - Or smart load connection and auto control
  - Or AC coupling function



## Specification

INPUT (PV DC)	GEN-LB-EU 7K	GEN-LB-EU 8K	GEN-LB-EU 10K
Max. PV array power(W)	12000	12000	15000
Rated PV input voltage(V)		360	
Number of independent MPPT inputs		2/(2:2)	
PV input voltage range(V)		100~600	
MPPT voltage range(V)		120~500	
Start-up voltage(V)		140	
Max. PV input current per MPPT(A)		25	
Max. PV short-circuit current input per MPPT(A)		34	
<b>Battery</b>			
Compatible battery type	Lithium-ion/Lead-Acid		
Rated battery voltage(V)	48		
Battery voltage range(V)	40~60		
Max. charge/discharge current(A)	146	167	210
Max. charge/discharge power(W)	7000	8000	10000
Force wake up battery from PV function(Y/N)	YES		
<b>Grid</b>			
Rated AC voltage(V)	230		
Rated AC frequency(Hz)	50/60		
Rated AC output current(A)	30.4	34.7	43.5
Rated AC output power(W)	7000	8000	10000
Max. AC input power(W)	15000		
PF	0.99 (Adjustable from 0.8 leading to 0.8 lagging)		
THDI	<3%		
Max. continuous AC passthrough current(A)	90		
<b>UPS</b>			
Rated output power(W)	7000	8000	10000
Rated output voltage(V)	230		
Rated output current(A)	30.4	34.7	43.5
Rated output frequency(Hz)	50/60		
Surge power, duration	2Pn, 0.5s		
Switching time	<20ms		
Wave form	Sine wave		
THDV	<3%		
<b>Efficiency</b>			
MPPT efficiency	99.9%		
Max. efficiency@PV to grid	97.5%		
Max. efficiency@battery to grid	94%		
Max. charge/discharge efficiency	94%		
<b>Protection</b>			
PV reverse polarity protection	YES		
Over current/voltage protection	YES		
Anti-islanding protection	YES		
AC Short-circuit current protection	YES		
Leakage current protection	YES		
Ground fault monitoring	YES		
Grid monitoring	YES		
DC Switch	YES		
AC/DC Surge protection Type III	YES		
<b>General</b>			
Dimensions(W*H*D)	536*556*290mm/21.1*21.9*11.4inch		
Weight	42.64kg/94lbs		
Ingress protection rating	IP65/NEMA 4X		
Relative humidity	0~100%		
Operating environment temperature range(°C)	-25~60		
Storage temperature range(°C)	-25~60		
Display & Communication interface	Touch color screen, RS485/Wifi/CAN		
Warranty	5 years		
Cooling method	Smart cooling		
Topology	Transformer-less		
Altitude	<2000m		
Noise emission(typical)	<50dB		
<b>Standard &amp; Certification</b>			
G99, G100, NRS 097			



# HYBRID SERIES

## Single-Phase

# LXP-LB-EU 12K

- **3 MPPTs, Max. 18kW of PV input**
- **12kW UPS output for backup during power cuts**
- **Supports up to 10pcs in parallel for on/off grid**
- **On/off grid seamless switching**
- **Separate port for**
  - Generator connection
    - Auto generator control
    - Support generator exercise
    - Support generator boost function
  - Or smart load connection and auto control
  - Or AC coupling function



## Specification

INPUT (PV DC)	LXP-LB-EU 12K
Max. PV array power(W)	18000
Rated PV input voltage(V)	360
Number of independent MPPT inputs	3/(2:1:1)
PV input voltage range(V)	100~600
MPPT voltage range(V)	120~500
Start-up voltage(V)	140
Max. PV input current per MPPT(A)	25/15/15
Max. PV short-circuit current input per MPPT(A)	31/19/19
Battery	
Compatible battery type	Lithium-ion/Lead-Acid
Rated battery voltage(V)	48
Battery voltage range(V)	40~60
Max. charge/discharge current(A)	250
Max. charge/discharge power(W)	12000
Force wake up battery from PV function(Y/N)	YES
Grid	
Rated AC voltage(V)	230
Rated AC frequency(Hz)	50/60
Rated AC output current(A)	50
Rated AC output power(W)	11500
Max. AC input current(A)	200
PF	0.99 (Adjustable from 0.8 leading to 0.8 lagging)
THDI	<3%
Max. continuous AC passthrough current(A)	200
UPS	
Rated output power(W)	11500
Rated output voltage(V)	230
Rated output current(A)	50
Rated output frequency(Hz)	50/60
Surge power, duration	2Pn, 0.5s
Switching time	20ms
Wave form	Sine wave
THDV	3%
Efficiency	
MPPT efficiency	99.9%
Max. efficiency	97.5%
Max. charge efficiency	94.0%
Max. discharge efficiency	94.0%
Protection	
PV reverse polarity protection	YES
Over current/voltage protection	YES
Anti-islanding protection	YES
AC Short-circuit current protection	YES
Leakage current protection	YES
Ground fault monitoring	YES
Grid monitoring	YES
DC Switch	YES
AC/DC Surge protection Type III	YES
General	
Dimensions(W*H*D)	490*670*265mm/19.3*26.3*10.4inch
Weight	50kg/110.2lbs
Ingress protection rating	IP65
Relative humidity	0~100%
Operating environment temperature range(°C)	-25~60°C, >45°C Derating
Storage temperature range(°C)	-25~60
Display & Communication interface	Touch color screen, RS485/Wi-Fi/CAN
Warranty	5 years
Cooling method	Smart Cooling
Topology	Transformer-less
Altitude	<2000m
Noise emission(typical)	<50dB
Standards & Certification	
EMC SANS 211:2010, CISPR 2015+A1:2016, IEC 61000-2-2-2012+A1:2017+A2:2018, Cape Town list, G99, G100, NRS 097-2-1:2017	



# HYBRID SERIES

## Split-Phase

# LXP-LB-US 8-10K

- 2 MPPTs with 4 strings input, Max. PV input 15kW
- Supports up to 10pcs in parallel for on/off grid
- On/off grid seamless switching
- Peak shaving function
- Separate port for
  - Generator connection
    - Auto generator control
    - Support generator exercise
    - Support generator boost function
  - Or smart load connection and auto control
  - Or AC coupling function
- AFCI protection integrated
- Breakers (Gen, Load and Battery) are integrated



## Specification

INPUT (PV DC)	LXP-LB-US 8K	LXP-LB-US 10K
Max. PV array power(W)	12000	15000
Rated PV input voltage(V)		360
Number of independent MPPT inputs		2/(2:2)
PV input voltage range(V)		100~600
MPPT voltage range(V)		120~500
Start-up voltage(V)		140
Max. PV input current per MPPT(A)		25/25
Max. PV short-circuit current input per MPPT(A)		31/31
<b>Battery</b>		
Compatible battery type		Lithium-ion/Lead-Acid
Rated battery voltage(V)		48
Battery voltage range(V)		40~60
Max. charge/discharge current(A)	167	210
Max. charge/discharge power(W)	8000	10000
Force wake up battery from PV function		YES
<b>Grid</b>		
Rated AC voltage(V)		240/208
Rated AC frequency(Hz)		60
Rated AC output current	33.3A@240V/38.5A@208V	41.6A@240V/48A@208V
Rated AC output power(W)	8000	10000
Max. AC input current(A)	63	63
PF	0.99 (Adjustable from 0.8 leading to 0.8 lagging)	
THDI	3%	
<b>UPS</b>		
Rated output power(W)	8000	10000
Rated output voltage(V)		120/240; 120/208
Rated output current	33.3A@240V/38.5A@208V	41.6A@240V/48A@208V
Rated output frequency(Hz)		60
Surge power, duration		2Pn, 0.5s
Switching time		20ms
Wave form		Sine wave
THDV		<3%
<b>Efficiency</b>		
Max. MPPT efficiency	99.9%	
Max. efficiency	97.5%	
Battery charge/discharge efficiency	94.0%	
CEC efficiency	96.4%	
<b>Protection</b>		
PV reverse polarity protection	YES	
Over current/voltage protection	YES	
Anti-islanding protection	YES	
AC short-circuit protection	YES	
Leakage current protection	YES	
DC switch	YES	
AC/DC surge protection Type III	YES	
Rapid shut down	YES	
Grid/AFCI/RSD monitoring	YES	
Grid/GEN breaker(Current/Voltage)	63A/480V	
Load breaker(Current/Voltage)	63A/480V	
Battery breaker(Current/Voltage)	250A/80V	
<b>General</b>		
Dimensions(W*H*D)	520*750*285mm/20.5*29.5*11.2inch	
Weight	50kg/110lbs	
Ingress protection rating	IP65/NEMA 4X	
Relative humidity	0~100%	
Operating environment temperature range	-25~60°C, >45°C Derating	
Storage temperature range(°C)	-25~60°C	
Display & Communication interface	Touch color screen, RS485/Wi-Fi/CAN	
Warranty	5/10 years	
Cooling method	Smart Cooling	
Topology	Transformer-less	
Altitude	<2000m	
<b>Standards &amp; Certification</b>		
E5000, SA17-18, CSA STD. C22.2 No.107.1 and 330, UL STD.1741, 1741SB, UL1998:2018, IEEE STD.1547 and 1547.1, IEEE STD. HECO SRD-IEEE-1547.1, ETL, cETLus, America CEC List, NEC. section690.12		





# HYBRID SERIES

## Split-Phase

# LXP-LB-US 12K

- 3 MPPTs with 4 strings input, Max. 18kW PV input
- 200A grid passthrough for whole home backup
- Supports up to 10pcs in parallel for on/off grid
- On/off grid seamless switching
- Peak shaving function
- AFCI protection integrated
- Separate port for
  - Generator connection
    - Auto generator control
    - Support generator exercise
    - Support generator boost function
  - Or smart load connection and auto control
  - Or AC coupling function



## Specification

INPUT (PV DC)	LXP-LB-US 12K
Max. PV array power(W)	18000
Rated PV input voltage(V)	360
Number of independent MPPT inputs	3/(2:1:1)
PV input voltage range(V)	100~600
MPPT voltage range(V)	120~500
Start-up voltage(V)	140
Max. PV input current per MPPT(A)	25/15/15
Max. PV short-circuit current input per MPPT(A)	31/19/19
Battery	
Compatible battery type	Lithium-ion/Lead-Acid
Rated battery voltage(V)	48
Battery voltage range(V)	40~60
Max. charge/discharge current(A)	250
Max. charge/discharge power(W)	12000
Force wake up battery from PV function	YES
Grid	
Rated AC voltage(V)	240/208
Rated AC frequency(Hz)	60
Rated AC output current(A)	50
Rated AC output power(W)	12000
Max. AC input current(A)	200
PF	0.99 (Adjustable from 0.8 leading to 0.8 lagging)
THDI	<3%
Max. continuous AC passthrough current(A)	200
UPS	
Rated output power(W)	12000
Rated output voltage(V)	120/240; 120/208
Rated output current(A)	50
Rated output frequency(Hz)	60
Surge power, duration	2Pn, 0.5s
Switching time	20ms
Wave form	Sine wave
THDV	<3%
Efficiency	
Max. MPPT efficiency	99.9%
Max. efficiency	97.5%
Battery charge/discharge efficiency	94.0%
CEC efficiency	96.9%
Protection	
PV reverse polarity protection	YES
Over current/voltage protection	YES
Anti-islanding protection	YES
AC Short-circuit protection	YES
Leakage current protection	YES
DC switch	YES
AC/DC surge protection Type III	YES
Rapid shut down	YES
Grid/AFCI/RSD monitoring	YES
Load breaker(Current)	200A
Battery breaker(Current/Voltage)	2*200A/80V
General	
Dimensions(W*H*D)	520*870*285mm/20.5*34.2*11.2inch
Weight	55kg/121.2lbs
Ingress protection rating	IP65/NEMA 4X
Relative humidity	0~100%
Operating environment temperature range(°C)	-25~60°C, >45°C Derating
Storage temperature range(°C)	-25~60
Display & Communication interface	Touch color screen, RS485/Wi-Fi/CAN
Warranty	5/10 years
Cooling method	Smart Cooling
Topology	Transformer-less
Altitude	<2000m
Standards & Certification	
E5000, SA17-18, CSA STD. C22.2 No.107.1 and 330, UL STD.1741, 1741SB, UL1998:2018, IEEE STD.1547 and 1547.1 IEEE STD. HECO SRD-IEEE-1547.1, ETL, CETLus, America CEC List, NEC. section690.12, FCC	



# HYBRID SERIES

## Three-Phase

# TriP 6-30K

- Max. 3 MPPTs and Max. PV input 45kW
- 150% unbalanced output, Max.15kW per phase
- Battery working range: 100~700V
- Max. 30kW UPS output
- Supports up to 10pcs in parallel for on/off grid
- Separate GEN port
- Smart load control
- Up to 21.6kW Gen/AC coupling input



## Specification

INPUT (PV DC)	TriP 6K	TriP 8K	TriP 10K	TriP 12K	TriP 15K	TriP 20K	TriP 30K
Max. PV array power (W)	9000	12000	15000	18000	22500	30000	45000
Rated PV input voltage (V)				690			
Number of independent MPPT inputs	2/(2:2)			3/(2:2:2)			
Max. PV input voltage (V)				1000			
MPPT voltage range (V)				200~900			
Start-up voltage (V)				100			
Max. PV input current per MPPT (A)	20/20			40/40/40			
Max. PV short-circuit current input per MPPT	25/25(A:1/B:1)			50/50/50(A:2/B:2/C:2)			
<b>Battery</b>							
Compatible battery type	Lithium-ion/Lead-Acid						
Rated battery voltage (V)	400						
Battery voltage range (V)	100~700						
Max. charge voltage (V)	700						
Max. charge/discharge current (A)	50						
Max. charge/discharge power (W)	6000	8000	10000	12000	15000	20000	30000
Force wake up battery from PV fuction	YES						
<b>Grid</b>							
Rated AC voltage (V)	230/400						
Rated AC frequency (Hz)	50						
Rated AC output current (A)	9.1	12.2	15.2	18.2	22.8	30.3	45.6
Rated AC output power (W)	6000	8000	10000	12000	15000	20000	30000
Max. AC input current (A)	13.6	18.2	22.8	27.3	34.1	45.5	68.2
PF	0.99 (Adjustable from 0.8 leading to 0.8 lagging)						
THDI	<3%						
Max. continuous AC passthrough current (A)	75						
<b>UPS</b>							
Rated output power (W)	230/400						
Rated output voltage (V)	6000	8000	10000	12000	15000	20000	30000
Rated output current (A)	50						
Rated output frequency (Hz)	9.1	12.2	15.2	18.2	22.8	30.3	45.6
Surge power, duration	1.5Pn, 10s						
Switching time	20ms						
Wave form	Sine wave						
THDV	<3%						
<b>Efficiency</b>							
Max. efficiency	97.4%						
Max.charge/discharge efficiency	97.2%						
<b>Protection</b>							
PV reverse polarity protection	YES						
Over current/voltage protection	YES						
Anti-islanding protection	YES						
AC Short-circuit protection	YES						
Leakage current protecion	YES						
Grid monitoring	YES						
DC switch	YES						
Ingress protection	YES						
DC Surge protection Type III	YES						
AC Surge protection Type III	YES						
<b>General</b>							
Dimensions ( W*H*D )	605*563*257mm/24*22.4*10.2inch						
Weight	IP65						
Ingress protection rating	38kg/83.8lbs			43kg/94.8lbs			
Operating environment temperature range(°C)	-25~60						
Storage temperature range(°C)	-40~70						
Relative humidity	0~100%						
Display & Communication interface	Touch color screen, RS485/Wifi/CAN						
Warranty	5 years						
Cooling method	Transformer-less						
Topology	Natural cooling			Smart cooling			
Altitude	<4000m						
Noise emission (typical)	<50dB						
<b>Standard &amp; Certification</b>							
EN62109-1, EN62109-2, EN62920, EN61000, NR5 097, NTS TYPEA, UNE217001, UNE217002, EN50549-1, EN50549-10, C10/11, TR3.3.1, VDE4105, TOR TYPEA, TOR TYPE B, G99, G100							

## ECO HYBRID

# SNA 3-6K

# SNA US 6K

# SNA 12K

# SNA US 12K

The ultimate pick for off-grid applications, empowering energy independence. seamlessly switching between on and off-grid modes, it's tailored for remote regions and unstable power scenarios, enabling direct off-grid usage.

## OUR CORE FEATURES

1

### 16pcs Parallel

With 16 units designed for parallel connections, this solution offers enhanced efficiency and flexibility for your power conversion needs.

Whether you're integrating solar panels, batteries, or other renewable energy sources, "16pcs Parallel" ensures seamless operation and optimized performance. Whether you're a professional or a DIY enthusiast, this product will be your ideal choice.

2

### Three-phase system with variable loads on each phase

Introducing our parallelized three-phase system, where each phase may have a different load. This state-of-the-art solution offers unmatched flexibility and efficiency for power distribution across diverse environments. Whether you're overseeing industrial machinery, commercial facilities, or residential grids, our system seamlessly adapts to varying loads on each phase. With robust performance and precise load management capabilities, it's perfect for optimizing energy usage and ensuring a dependable power supply.

3

### Separate Generator Port Available

This addition expands the diversity of energy independence options by providing additional flexibility in power source selection. Whether you're incorporating solar panels, batteries, or generators, our system offers seamless integration and optimized performance. With its adaptable design and expanded options, it's the ideal solution for diversifying energy sources and ensuring reliable power supply in various scenarios.

4

### 480V High Voltage PV Input

With this capability, our system allows for the integration of as many solar panels as possible, optimizing energy generation potential. Whether for residential, commercial, or industrial applications, this feature ensures efficient utilization of solar resources and enhanced energy output. Say goodbye to limitations and hello to unparalleled solar power flexibility with our high PV voltage input.

# ECO HYBRID

## Single-Phase

# SNA 3-6K

- Off-grid seamless switching
- 2 MPPTs, Max. PV input: 8kW
- Wide PV input voltage range: 100~480V
- Supports up to 16pcs in parallel
- Max. charging and discharging current 140A
- Dedicated Port: Supports generator, AC coupling or smart load management for enhanced stability
- 24/7 real-time monitoring via LUX app with worry-free updates

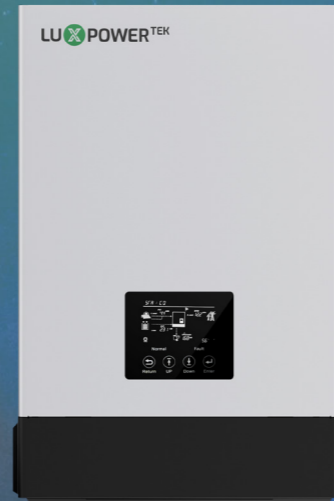

## Specification

Your Reliable  
Energy Solution  
Partner

Input (PV DC)	SNA 3000W	SNA 4000W	SNA 5000W	SNA 6000W
Max. PV array power(W)	6000 (3000/3000)	8000 (4000/4000)	8000 (4000/4000)	8000 (4000/4000)
Rated PV input voltage(V)	320			
Number of independent MPPT inputs	2/(1:1)			
PV input voltage range(V)	100~480			
MPPT voltage range(V)	120~385			
Start-up voltage(V)	100			
Max. PV input current per MPPT(A)	17/17			
Max. PV short-circuit current input per MPPT(A)	25/25			
<b>Battery</b>				
Compatible battery type	Lithium-ion/Lead-Acid			
Rated battery voltage(V)	48			
Battery voltage range(V)	38.4~60			
Max. charge/discharge current(A)	70/70	90/90	110/110	140/140
Max. charge/discharge power(W)	3000	4000	5000	6000
Recommend capacity of battery per inverter	>100AH	>200AH	>200AH	>200AH
Force wake up battery from PV function	YES			
Force wake up battery from Grid function	YES			
<b>Grid</b>				
Rated AC voltage(V)	230			
Rated AC frequency(Hz)	50/60			
Rated AC output current(A)	13.5	17.5	22	26.5
Rated AC output power(W)	3000	4000	5000	6000
Max. AC input power(W)	8000			9000
PF	0.99 (Adjustable from 0.8 leading to 0.8 lagging)			
THDI	<5%			
Max. continuous AC passthrough current(A)	35			40
<b>UPS</b>				
Rated output power(W)	3000	4000	5000	6000
Rated output voltage(V)	230			
Rated output current(A)	13.5	17.5	22	26.5
Rated output frequency(Hz)	50/60			
Surge power, duration	2Pn, <2s			
Switching time	<15ms@Single/<30ms@Parallel			
Wave form	Sine wave			
THDV	3%			
<b>Efficiency</b>				
Max. MPPT efficiency	99.9%			
Max. efficiency	93.0%			
Max. charge efficiency	93.0%			
Max. discharge efficiency	93.0%			
<b>Protection</b>				
Over current/voltage protection	YES			
AC Short-circuit current protection	YES			
Grid monitoring	YES			
AC Surge protection Type III	YES			
Battery reverse polarity protection	YES			
<b>General</b>				
Dimensions(W*H*D)	330*505*135mm/13*19.9*5.3inch			
Weight	14.5kg/32lbs			
Ingress protection rating	IP20			
Operating environment temperature range(°C)	0~50			
Storage temperature range(°C)	-15~60			
Relative humidity	5%~95%			
Display & Communication interface	LCD+LED, RS485/Wi-Fi/CAN			
Warranty	2 years			
Cooling method	Smart Cooling			
Topology	Transformer-less			
Altitude	<2000m			
Noise emission(typical)	<50dB			
<b>Standards &amp; Certification</b>				
IEC 62109-1, IEC 61000, IEC62040/EN62040, IEC62109, NRS 097-2-1				

# ECO HYBRID

## Single-Phase

# SNA 12K

- **2 MPPTs with 4 strings, Max. 24kW PV input**
- **Max. charging and discharging current: 250A**
- **Off-grid application for high demand with 12kW output power**
- **Dual AC output ports for multiple load connections**
- **Separate GEN port**
  - Up to 19.2kW Gen/AC coupling input
  - Auto generator start and stop control
- **Integrated Design with Load and Battery Breaker**
- **PV or AC or Generator wake up battery**



## Specification

INPUT (PV DC)		SNA 12K
Max. PV array power (W)		24000 (12000/12000)
Rated PV input voltage (V)		320
Number of independent MPPT inputs		2/(2:2)
PV input voltage range (V)		100-480
MPPT voltage range (V)		120-385
Start-up voltage (V)		100
Max. PV input current per MPPT (A)		35/35
Max. PV short-circuit current input per MPPT (A)		44/44
Battery		
Compatible battery type		Lithium-ion/Lead-Acid
Rated battery voltage (V)		48/51.2
Battery voltage range (V)		46.4-60/38.4-60
Max. charging / discharging current (A)		250
Max. charging / discharging power (W)		12000
Force wake up battery from PV and Grid function		YES
Grid		
Rated AC voltage (V)		230
Acceptable Input Voltage Range (V)		90~280
Rated AC frequency (Hz)		60/50
Rated AC input current (A)		100
Rated AC input power (W)		24000
PF		0.99
THDI		<5%
Max. continuous AC passthrough current(A)		100
UPS		
Rated output power (W)		12000
Rated output voltage (V)		230
Rated output current (A)		50
Rated output frequency (Hz)		50/60
Surge power, duration		2Pn, 5s
Switching time (UPS)		<10ms@Single and Parallel
Wave form		Sine wave
THDV		3%
GEN		
Acceptable input voltage range		230
Max. AC input voltage (V)		280
Max. AC input current (A)		63
Rated input frequency		50Hz/60Hz (Auto detection)
Transfer time		<10ms@Single; <20ms@Parallel
THDV		<3%
Overload protection		5s@≥150% load /10s@110%~150% load
Efficiency		
Max. efficiency		93.5%
Max. charging / discharging efficiency		93.0%
Max. MPPT efficiency		99.0%
Protection		
PV reverse polarity protection(Y/N)		YES
Over current / voltage protection(Y/N)		YES
AC Short-circuit current protection(Y/N)		YES
Grid monitoring(Y/N)		YES
DC switch(Y/N)		YES
DC / AC Surge protection Type III		YES
Battery reverse polarity protection(Y/N)		YES
General		
Dimensions ( W*H*D mm )		530*830*150mm(17.72*25.59*5.9inch)
Weight		40kg/88.2lbs
Ingress protection rating		IP20
Operating environment temperature range(°C)		0~45
Storage temperature range(°C)		-15~60
Relative humidity		5% ~ 95%
Display & Communication interface		LCD+RGB, RS485 / Wifi / CAN
Warranty		2 years
Cooling method		Smart cooling
Topology on AC / Battery side		Transformer-less / Transformer
Altitude (m)		<2000
Noise emission (typical)		<50dB
Standard & Certification		
CE		



# ECO HYBRID

## Split-Phase

# SNA US 6000

- 240V/120V off-grid split-phase output
- Supports up to 16pcs in parallel
- Off-grid seamless switching
- AFCI protection integrated
- Dedicated port for generator, AC coupling or smart load management
- Breakers (Gen, Load and Battery) and PV switch are integrated



## Specification

Input (PV DC)		SNA-US 6000
Max. PV array power (W)		8000(4000/4000)
Rated PV input voltage(V)		320
Number of independent MPPT inputs		2/(1:1)
PV input voltage range(V)		100~480
MPPT voltage range(V)		120~385
Start-up voltage(V)		100
Max. PV input current per MPPT(A)		17/17
Max. PV short-circuit current input per MPPT(A)		25/25
Battery		
Compatible battery type		Lithium-ion/Lead-Acid
Rated battery voltage(V)		48
Battery voltage range(V)		38.4~60
Max. charge/discharge current(A)		125/140
Max. charge/discharge power(W)		6000
Force wake up battery from PV function		YES
Force wake up battery from Grid function		YES
Grid		
Rated AC voltage(V)		110(L-N)/220(L1-L2); 120(L-N)/240(L1-L2)
Rated AC frequency(Hz)		50/60
Max. AC input current(A)		41A@220V/37.5A@240V
Max. AC input power(W)		9000
Max. continuous AC passthrough current(A)		50
GEN		
Rated GEN voltage(V)		120/240
Rated GEN frequency(Hz)		50/60
Rated GEN input current(A)		32
Rated GEN input power(W)		7370
Rated GEN current of BYPASS relays(A)		60
UPS		
Rated output power(W)		6000
Rated output voltage(V)		110/220; 120/240
Rated output current(A)		28A@220V/25A@240V
Rated output frequency(Hz)		50/60
Surge power, duration		2Pn, <2s
Switching time		<15ms@Single/<30ms@Parallel
Wave form		Sine wave
THDV		<3%
Efficiency		
Max. MPPT efficiency		99.9%
Max. efficiency		93.0%
Max. charge/discharge efficiency		93.0%
Protection		
Over current/voltage protection		YES
AC short-circuit current protection		YES
Grid monitoring		YES
AC Surge protection Type III		YES
Battery reverse polarity protection		YES
DC switch		YES
Rapid shut down		YES
PV Arc Fault Detection		YES
AC & UPS breaker(Current/Voltage)		50A/230VAC
Battery breaker (Current/Voltage)		200A/80V/DC
GEN breaker (Current/Voltage)		50A/230V/AC
General		
Dimensions(W*H*D)		450*650*150mm/17.7*25.6*5.9inch
Weight		24kg/53lbs
Ingress protection rating		IP20
Operating environment temperature range(°C)		0~50
Storage temperature range(°C)		-15~60
Relative humidity		5%~95%
Display & Communication interface		LCD+LED, RS485/Wi-Fi/CAN
Warranty		2 years
Cooling method		Smart Cooling
Topology		Transformer-less
Altitude		<2000m
Noise emission(typical)		<50dB
Standard & Certification		
CSA STD. C22.2 No.107.1, UL STD.1741		

\*Note: 115A @48VDC (AC), 125A @44VDC (AC), 125A @48VDC (PV)



# ECO HYBRID

## Split-Phase

# SNA US 12K

- 240/120V off-grid split-phase output
- 2 MPPTs with 4 strings, Max. 24kW PV input
- Max. charging and discharging current: 250A
- AFCI Protection Integrated
- Dual AC output ports for multiple load connections
- Separate GEN port
  - Up to 19.2kW Gen/AC coupling input
  - Auto generator start and stop control
- Integrated Design with Load and Battery Breaker
- PV or AC or Generator wake up battery
- AC/Generator (input 240V or 120V) charge function



## Specification

INPUT (PV DC)		SNA US 12000W
Max. PV array power (W)		24000 (12000/12000)
Rated PV input voltage (V)		320
Number of independent MPPT inputs		2/(2:2)
PV input voltage range (V)		100~480
MPPT voltage range (V)		120~385
Start-up voltage (V)		100
Max. PV input current per MPPT (A)		35/35
Max. PV short-circuit current input per MPPT (A)		44/44
Battery		
Compatible battery type		Lithium-ion/Lead-Acid
Rated battery voltage (V)		48/51.2
Battery voltage range (V)		46.4-60/38.4-60
Max. charging / discharging current (A)		250
Max. charging / discharging power (W)		12000
Force wake up battery from PV and Grid function		YES
Grid		
Rated AC voltage (V)		110/220; 120/240
Acceptable input voltage range (V)		90~280
Rated AC frequency (Hz)		60/50
Rated AC input current (A)		105@220V/100@240V
Rated AC input power (W)		24000
PF		0.99
THDI		<5%
Max. continuous AC passthrough current(A)		100
UPS		
Rated output power (W)		12000
Rated output voltage (V)		110/220; 120/240
Rated output current (A)		54@220V/50@240V
Rated output frequency (Hz)		50/60
Surge power, duration		2Pn, 5s
Switching time (UPS)		<10ms@Single and Parallel
Wave form		Sine wave
THDV		3%
GEN		
Acceptable input voltage range		110/220; 120/240
Max. AC input voltage (V)		280
Max. AC input current (A)		63
Rated input frequency		50Hz/60Hz (Auto detection)
Transfer time		<10ms@Single; <20ms@Parallel
THDV		<3%
Overload protection		5s@≥150% load /10s@110%~150% load
Efficiency		
Max. efficiency		93.5%
Max. charging / discharging efficiency		93.0%
Max. MPPT efficiency		99.0%
Protection		
PV reverse polarity protection(Y/N)		YES
Over current / voltage protection(Y/N)		YES
AC Short-circuit current protection(Y/N)		YES
Grid monitoring(Y/N)		YES
DC switch(Y/N)		YES
DC Surge protection Type III		YES
AC Surge protection Type III		YES
Battery reverse polarity protection(Y/N)		YES
RSD / AFCI monitoring(Y/N)		YES
UPS/Battery breakers integrated		YES
General		
Dimensions ( W*H*D mm )		530*830*150mm (17.72*25.59*5.9inch)
Weight		45kg/99.2lbs
Ingress protection rating		IP20
Operating environment temperature range(°C)		0~45
Storage temperature range(°C)		-15~60
Relative humidity		5%~95%
Display & Communication interface		LCD+RGB, RS485 / Wifi / CAN
Warranty		2 years
Cooling method		Smart cooling
Topology on AC / Battery side		Transformer-less / Transformer
Altitude (m)		<2000
Noise emission (typical)		<50dB
Standard & Certification		
		/



# RETROFIT

## AC Retrofit

- LXP 3600 ACS / LXP 3600 SQPOD

## DC Retrofit

- LSP 100K

# One Step to Retrofit Your Solar System

## / AC Retrofit

Retrofit an existing on-grid solar system to add battery storage.

It couldn't be easier than installing an LXP AC series inverter coupled on AC side with a battery pack. Installation of a Lux AC system should not affect existing solar systems or feed in tariffs.

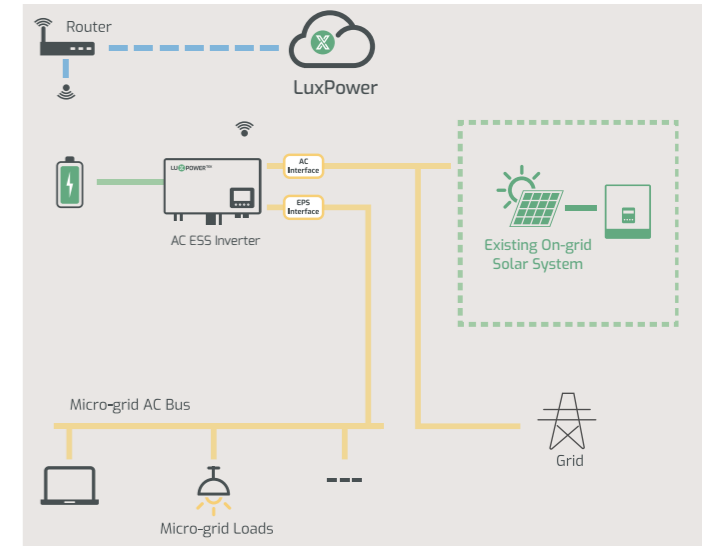

## / DC Retrofit

To retrofit an existing PV system by incorporating DC side coupling to create an energy storage system. With this enhanced storage system:

It becomes compatible with batteries, enabling the addition of more PV panels, while also allowing the PV system to operate on a predefined schedule; -By setting the charging/discharging timeline of the battery, it achieves an equivalent/similar effect as the Peak Shaving operating mode.

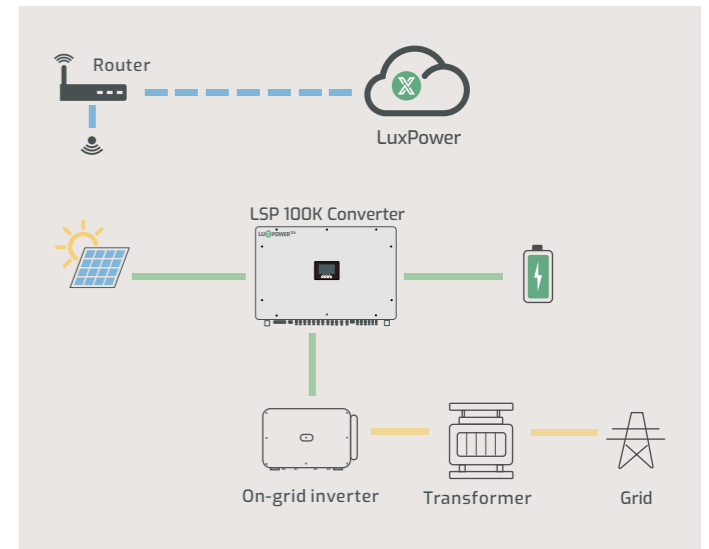



## AC RETROFIT

# LXP 3600 ACS



- Retrofit any on-grid/micro-grid system to energy storage system
- Battery charging/discharging current: 70A
- Octopus smart time of use and weather optimize
- On/off grid seamless switching
- Support up to 8pcs in parallel
- Separate EPS port for flexible load management



**NOTE:**

Intelligent charge feature is only available in the UK for now,

supporting regional customization



## Specification

Battery		LXP 3600 ACS/LXP 3600 SQPOD
Compatible battery type	Lithium-ion/Lead-Acid	
Rated battery voltage(V)	48	
Battery voltage range(V)	40-60	
Max. charge voltage(V)	60	
Max. charge/discharge current(A)	70	
Max. charge/discharge power(W)	3600	
Force wake up battery from Grid fuction(Y/N)	YES	
Grid		
Rated AC voltage(V)	230	
Rated AC frequency(Hz)	50/60	
Rated AC output current(A)	16	
Rated AC output power(W)	3600	
Max. AC input current(A)	26	
PF	0.99 (Adjustable from 0.8 leading to 0.8 lagging)	
THDI	< 3%	
Max. continuous AC passthrough current(A)	40	
UPS		
Rated output power(W)	3600	
Rated output voltage(V)	230	
Rated output current(A)	16	
Rated output frequency(Hz)	50/60	
peak power, duration	4500W, 30s	
Switching time	20ms	
Wave form	Sine wave	
THDV	< 3%	
Parallel capacity	6	
Efficiency		
Max. efficiency	97.3%	
Max. charge efficiency	94.5%	
Max. discharge efficiency	94.5%	
Protection		
Over current/voltage protection	YES	
Anti-islanding protection	YES	
AC Short-circuit current protection	YES	
Grid monitoring	YES	
AC Surge protection Type III	YES	
General		
Dimensions(W*H*D)	650*440*220mm/25.6*17.3*8.6inch	
Weight	15.6kg/34.4lbs	
Ingress protection rating	IP65	
Operating environment temperature range(°C)	-25~60	
Storage temperature range(°C)	-40~65	
Relative humidity	0~95%	
Display & Communication interface	LCD, RS485/Wi-Fi/CAN	
Warranty	5 years	
Cooling method	Natural Cooling	
Topology	Transformer-less	
Altitude	2000m	
Noise emission(Typical)	< 25dB	
AC connector	YES	
Standards & Certification		
IEC62109-1, IEC62040, EN 61000-6-1:2007, EN 61000-6-3:2007+A1:2011+ AC:2012, EN 61000-3-2:2014, EN 61000-3-3:2013, VDE-AR-N 4105 EN50549-1, G98, G100		

## AC RETROFIT

# LXP 3600 SQPOD



- Modular expansion – link up to 6 units together
- Number of batteries - Min. 1, Max. 8 (5.12kWh for each battery)
- Retrofit any on-grid/micro-grid system to energy storage system
- EPS (Emergency Power Supply) functionality
- Free online monitoring platform
- Weather Compensation smart charge feature
- Multiple Works with Octopus auto charge packages  
-Suggesting 40kwh for each machine, can be more

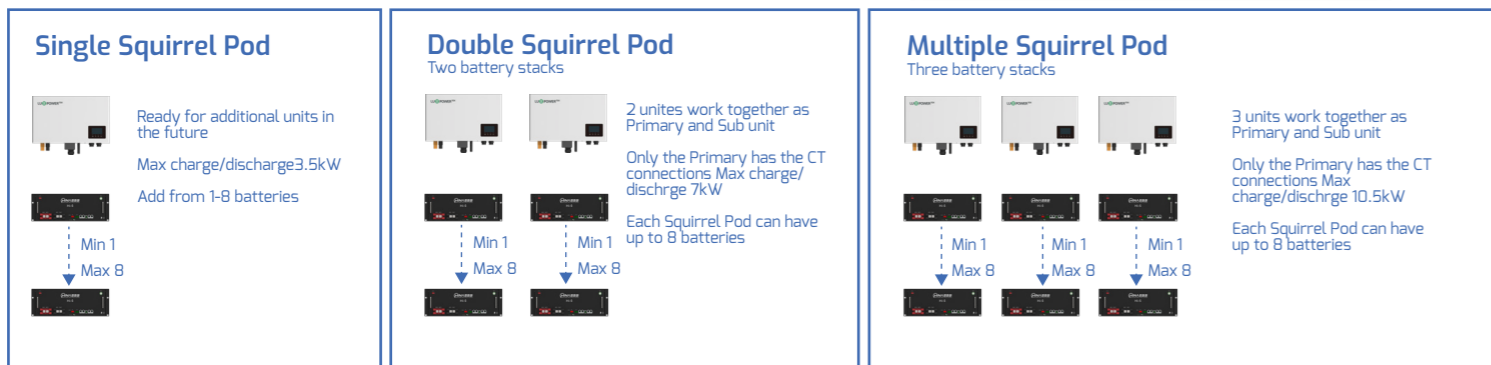

## Lux Power Battery Storage Agile Auto Charge

Luxpower and Infinity Innovations Ltd. have developed an Agile Auto Charge (AAC) to allow automatic off-peak charging using the cheapest rates available. This is a Beta system and therefore reacts to data provided by Octopus. Lux Power has no involvement or responsibility for the content or timing of the information provided. It is recommended that you read the Octopus Blog regarding all systems approved as compatible with Octopus.

<https://octopus.energy/blog/works-with-octopus/>

The AAC analyses the time and prices of the electricity information published by Octopus Energy and ranks the information by the price. You can therefore just input the number of charge periods you want to use, and the system will automatically charge using only the cheapest periods.

### Simple to Programme

Agile Auto Charge will appear on your Luxpower Portal once activated by Infinity Innovations Ltd. Simply select the quantity of 30-min charge periods you require for Night or Day charging and press save!

### Night Charge - From midnight to 6am.

Select the desired number of charge periods, and your system will automatically adjust to charge during periods when prices are at their lowest.

### Day Charge - From 12 noon to 4pm.

This will allow you to top-up your batteries ready to get through the more expensive On-Peak periods.

### Blocking Discharge

You can also set periods where the batteries can charge but will not discharge. For example, block discharging from midnight to 6am and your batteries will charge using only the cheapest rates but will not discharge. So you can set all heavy usage items - washing machines, dishwashers, EV charging etc. to also run at night without emptying your batteries. Using this function, you can ensure your batteries are 100% charged ready cover your house load at 6am.

# LSP 100K

## Thanks to LSP 100K, it's now easy

To retrofit an existing PV system by incorporating DC side coupling to create an energy storage system. With this enhanced storage system:

- It becomes compatible with batteries, enabling the addition of more PV panels, while also allowing the PV system to operate on a predefined schedule.
- By setting the charging/discharging timeline of the battery, it achieves an equivalent/similar effect as the peak-shaving operating mode.



- Max. 200kW PV input and 100kW PV output
- 24/7 real-time monitoring via free LUX app and web
- Retrofit on-grid system to hybrid system (energy storage)
- Advanced power management logic
- DC-coupling, 24 MPPT inputs and 12 MPPT outputs
- Colorful touch LCD, IP65 for indoor/outdoor installation

## Specification

INPUT (PV DC)	LSP 100K
Max. input power(kW)	200
Max. input voltage(V)	1100
Rated PV input voltage(V)	630
MPPT voltage range(V)	300~1000
Start-up voltage(V)	330
Max. short-circuit per MPPT(A)	33
Max. current per MPPT input(A)	26
Number of MPPT inputs	12
Number of input strings	24
Battery	
Type	Lithium-ion/Lead-acid
Max. charge/discharge power(kW)	100
Voltage range(V)	300~700
Max. charge/discharge current(A)	200
Max. charge/discharge efficiency	98.1%
PV output	
DC-DC output rated power(kW)	100
Normal output voltage(V)	630
Output voltage range(V)	500~1000
Max. output current(A)	20
Output strings	12
Output trackers	12
Protection	
DC reverse-polarity protection	Yes
DC surge arrester	Type II
General	
Dimensions(W*H*D)	1015*680*310mm/39.9*26.8*12Inch
Weight(with mounting plate)	120kg/264.5lbs
Protection degree rating	IP65
Topology	Transformer-less
Cooling method	Natural Cooling
Relative humidity	0%~100%
Operating environment temperature range(°C)	-25~60
Connector(PV input and Output)	MC4
Battery connector	Screw
Altitude	<4000m
Warranty	5 years
Display	Touch color screen, LED+LCD
Communication interface	RS485/CAN/Wi-Fi
Standards & Certifications	
EN 62109-1 / -2, IEC 62109-1 / -2	

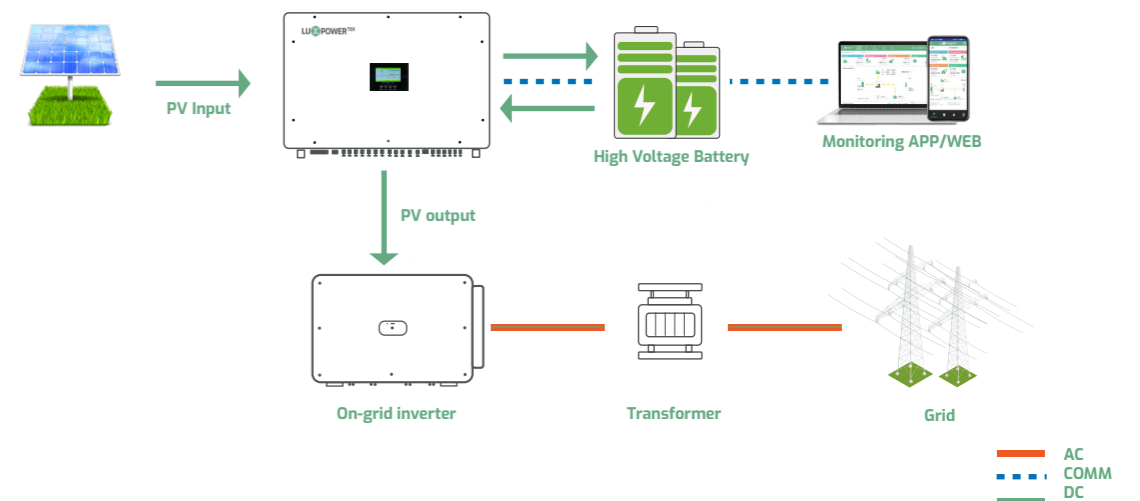

# ALL IN ONE

## Single-Phase

# Eco Beast

- 2 MPPTs, Max. 8kW PV input
- Expandable storage – Up to 16pcs in parallel
- Battery module level monitoring
- On/off-grid switching
- Remote monitoring and firmware updates with battery
- PV or AC or Generator wake up battery

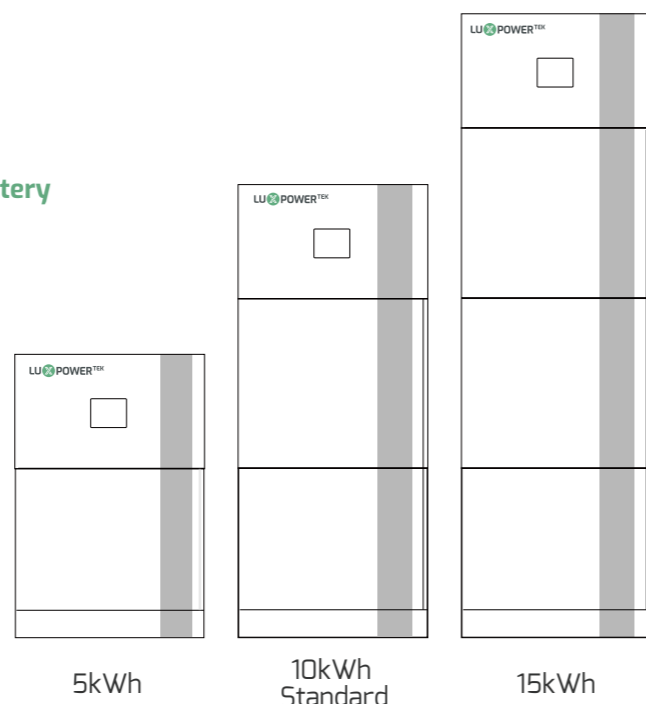

## Specification

INVERTER MODULE	
<b>Input (PV DC)</b>	
Max. PV array power (W)	8000(4000/4000)
Rated PV input voltage (V)	320
Number of Independent MPPT inputs	2/(1:1)
pV Input voltage Range (V)	100~480
MPPT voltage range (V)	120~385
Start-up voltage (V)	100
Max. PV Input current per MPPT (A)	17/17
Max. PV short-circuit current per MPPT (A)	25/25
Max. PV charging current (A)	125
<b>Battery Input</b>	
Battery Volatge (V)	38.4~60
Max. charging/discharging current (A)	125/140
Max. charging/discharging power (W)	6000
<b>UPS output @ off-grid</b>	
Output voltage waveform	Pure sine wave
Output voltage regulation (V)	208/220/230/240±5%
Output frequency (Hz)	50/60
Rated output power (W)	6000
Rated output current (A)	26.5
Peak efficiency	93%
Overload protection	5s@≥150% overload; 10s@110%~150% overload
Surge power	2*Pn, 5s
Parallel quantity	16pcs
<b>AC Input</b>	
Nominal input voltage (V)	230
Nominal input frequency (Hz)	50/60(Auto detection)
Max. AC input current (A)	39.5
Max. AC input power (W)	9000
Max. AC charging current (A)	125
<b>AC Output @ Grid</b>	
Rated AC output current (A)	26.5
Rated AC output power (W)	6000
Rated AC current of bypass relays (A)	60
Switching time	Typical<10ms@Single; <30ms@Parallel
<b>Generator Input</b>	
Rated GEN voltage (V)	220/230/240
Rated GEN frequency (Hz)	50/60
Rated GEN input Current (A)	32
Rated GEN input Power (W)	7370
Rated GEN current of bypass relays (A)	60
<b>Battery MODULE</b>	
Battery power (kWh)	5.12
Rated voltage (V)	51.2
Rated capacity (Ah)	100
Battery type	Lithium-ion
Max. pallel (Default)	2PCS
Max. discharging current (A)	100
Max. charging current (A)	100
Dimension (W*H*D) (mm)	580*434*165
Net weight	54
Standard	UN38.3, CE
<b>Protection/General Specifications</b>	
Grid monitoring	YES
AC surge protection type III	YES
Safety certification	CE, UN38.3, NRS097
Dimension(W*H*D) (mm)	580*1300*165(default)
Weight	125.4kg/276.4lbs
Ingress protection rating	IP20
Display & Communication interface	LCD+LED, RS485/Wi-Fi/CAN
Cooling method	Smart cooling
Topology	Transformer-less
Noise emission(typical) (dB)	<58
Operating temperature range (°C)	0~45
Storage temperature (°C)	-15~60
Humidity	5% to 95% Relative Humidity (Non-condensing)
Altitude (m)	<2000
<b>Standards &amp; Certification</b>	
NR5097-2-1:2024	

# ALL IN ONE

## Split-Phase

# LiteStor

- 202/101, 240/120V split-phase output
- 3 MPPTs with 6 strings, Max. PV input 18kW
- 100Ah battery cells, long cycle life
- 10-20kWh battery modules optional
- IP65 protection rating, install anywhere
- Multi system boot-up sources, uninterrupted usage

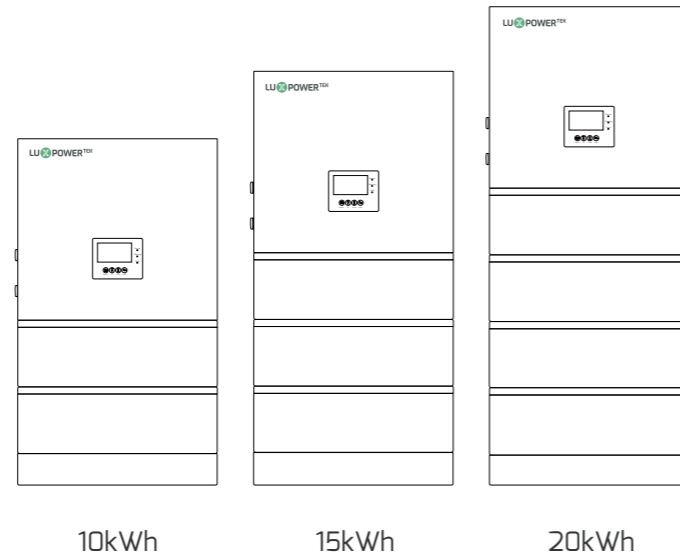

10kWh

15kWh

20kWh



## Specification

INVERTER MODULE			
<b>DC Input(from PV)</b>			
Max. PV power(W)			18000
Max. DC input voltage(V)			600
Max. input current per MPPT(A)			18
Max. short circuit input current per MPPT(A)			22.5
Nominal DC input voltage(V)			360
Start input voltage(V)			100
Startup voltage(V)			140
DC voltage range(V)			100~600
MPP operating voltage range(V)			120~500
Number of MPPT			3
Number of PV strings per MPPT			1:1:1
<b>AC Input</b>			
Nominal input power(W)			10000
Max. input apparent power(W)			15000
Nominal grid voltage(V)			202/101
Nominal input current(A)			50
Max. input current(A)			75
Nominal grid frequency(Hz)			50/60
Power factor			-0.8~0.8
<b>Off-grid Output</b>			
Continuous output power(W)			10000
Nominal output voltage(V)			202/101
Nominal output current(A)			50
Nominal output frequency(Hz)			50/60
THDV			<3%
Switching time			10ms
<b>Battery Module</b>			
Type			LiFePO <sub>4</sub>
Nominal charge current(A)			50
Max. charge current			105 (15s)/110 (500ms)
Nominal discharge current(A)			100
Max. discharge current			105 (15s)/120 (500ms)
Nominal discharge voltage(V)			51.2
Voltage range(V)			44.8-57.6
Nominal charge voltage(V)			56.5
Nominal output power(W)			5120
Nominal capacity(Ah)			100
<b>System charge/discharge Data</b>			
Max. charge current(A)			250
Max. discharge current(A)			250
<b>General Data</b>			
Integrated disconnect		DC switch	
Dimension	640mm*410mm*1100mm/10kWh	640mm*410mm*1315mm/15kWh	640mm*410mm*1530mm/20kWh
Weight	172.5kg/10kWh	233.6kg/15kWh	295kg/20kWh
Ingress protection rating	IP65		
Cooling method	Smart cooling		
Operating temperature range(°C)	-25~60		
Relative humidity	0-100%		
Altitude	<2000m		
Internal consumption(W)	<15		
Display	Touch color screen		
Monitoring	RS485/ Wi-Fi/ CAN		
<b>Standards &amp; Certification</b>			

# Empower Your Home with Battery Storage

Elevate your energy management capabilities with our cutting-edge battery storage solutions. Designed to complement our innovative inverters, our battery systems provide seamless integration and enhanced performance.

With our energy storage system, you gain the ability to store excess energy generated during the day for use during peak hours or emergencies, ensuring uninterrupted power supply.

Our smart monitoring features allow you to monitor energy usage in real-time and optimize consumption patterns, providing greater control over your energy costs and environmental footprint. Embrace the future of energy efficiency with our comprehensive energy solutions.



# Battery Storage

## Li-5

- 10 years warranty
- Ultra safe LFP material
- Short circuit protection
- Flexible remote upgrade
- Wide range inverter compatibility
- Parallel up to 32 modules
- 1C rate continuous charge/discharge
- Multi protection to avoid over discharge
- Smart BMS management for longer lifespan
- Active balancing charging, low self consumption



## Specifications

Model	Li-5
Cell Type	LFP
Rated Power	5.12kWh
Rated Capacity	100Ah
Rated Voltage	51.2V
Charge Voltage	56.5V
Max. Charge/Discharge Current	100A
Discharge Peak Current	105A / 15s, 150A / 0.5s
Parallel	Up to 32 units parallelable w/o extra device needed, slave battery drops offline or come back alive does not affect system running
IP Level	IP20
Dimension(W*D*H mm)	452.6*165*481mm
Weight	50kg/110.2lbs
Communication	CAN/RS485
Compatible Inverter	Victron, Luxpower, Deye, Voltronic, SMA Goodwe, Growatt, Sofar, Solark, SRNE, Must
Humidity	5%~85% RH (No condensation)
Work Temperature	20 ~ +55 °C
Storage Temperature	-10 ~ +35 °C
Remote Maintenance	Flexible remote upgrade, Original firmware backup to prevent upgrade failure
Warranty *	10 years, 6000 cycles
Certification	CE UN38.3; IEC62619
Protection	Overcharge/discharge/current/voltage/temperature protection Short circuit protection, Reverse connection protection Charge balance, Low SOC protection



# Battery Storage

## PGEM

- Quick installation
- Remote monitoring
- Flexible remote upgrade
- Auto-addressing for master/slaves set up
- Parallel up to 32 modules
- Wide range inverter compatibility
- 1C rate continuous charge/discharge
- Multi protection to avoid over discharge
- Smart BMS management for longer lifespan
- Active balancing charging, low self consumption



## Specifications

Your Reliable  
Energy Solution  
Partner

Model	PGEM
Cell Type	LFP
Rated Power	5.12kWh
Rated Capacity	100Ah
Rated Voltage	51.2V
Charge Voltage	56.5V
Max. Charge/Discharge Current	100A
Discharge Peak Current	105A / 15s, 150A / 0.5s
Parallel	Up to 32 units parallelable w/o extra device needed, slave battery drops offline or come back alive does not affect system running
IP Level	IP20
Dimension(W*D*H mm)	428*640*166mm
Weight	58kg/127.9lbs
Communication	CAN/RS485
Compatible Inverter	Victron, Luxpower, Deye, Voltronic, SMA Goodwe, Growatt, Sofar, Solark, SRNE, Must
Humidity	5%~85% RH (No condensation)
Work Temperature	-20 ~ +55 °C
Storage Temperature	-10 ~ +35 °C
Remote Maintenance	Flexible remote upgrade, remote monitoring Original firmware backup to prevent upgrade failure
Warranty *	10 years, 6000 cycles
Certification	CE UN38.3; IEC62619
Protection	Overcharge/discharge/current/voltage/temperature protection Short circuit protection, Reverse connection protection Stronger active balance, Low SOC protection





## PGEM PRO

- 0.5C Continuous Power
- 10 years warranty
- 32 Units Stackable
- Ultra safe LFP material
- Short circuit protection
- Flexible remote upgrade
- Wide range inverter compatibility
- Multi protection to avoid over discharge
- Smart BMS management for longer lifespan
- Active balancing charging, low self consumption



## Specifications

Model	PGEM PRO
Cell Type	LFP
Rated Power	14.3kWh
Rated Capacity	280Ah
Rated Voltage	51.2V
Charge Voltage(Vdc)	56.5V
Battery Charge Current(A)	140 (max. continuous) 150 (start limit current to 10A, retest every 10 minutes) 160 (peak1 15S) 180 (peak2 500ms)
Battery DisCharge Current(A)	140 (max. continuous) 150 (start giving over-current alarm but not stop discharging) 160 (peak1 5minutes) 200 (peak2 500ms)
Parallel	Up to 32 units parallelable w/o extra device needed, slave battery drops offline or come back alive does not affect system running
IP Level	IP20
Dinmension(W*D*H mm)	475*900*238mm
Weight	115kg/253.5lbs
Communication	CAN/RS485
Robust Applications	Auto-addressing and stronger protection
DOD	90%
Cycles	8000
Compatible Inverter	Victron, Luxpower, Deye, Voltronic, SMA Goodwe, Growatt, Sofar, Solark, SRNE, Must
Humidity	5%~85% RH (No condensation)
Work Temperature	-20 ~ +55 °C
Storage Temperature	-10 ~ +35 °C
Remote Maintenance	Flexible remote upgrade, Original firmware backup to prevent upgrade failure
Warranty*	10 years, 8000 cycles
Certification	CE UN38.3; IEC62619
Protection	Overcharge/discharge/current/voltage/temperature protection Short circuit protection, Reverse connection protection Charge balance, Low SOC protection

## Battery Storage

# PSHIELD

- **IP65 enclosure & Built-in heating system, designed for outdoor use & extreme weather.**
- **DC Breaker built-in.**
- **Parallel up to 32 modules.**
- **Wide range inverter compatibility.**
- **1C rate continuous charge/discharge.**
- **Ultra safe LFP material, 10-year warranty.**
- **Handy monitor & flexible remote upgrade.**
- **Second level protection, robust applications.**
- **Smart BMS management for longer lifespan.**
- **Active balancing charging, low self consumption.**



## Specifications

Your Reliable  
Energy Solution  
Partner

Model	PSHIELD
Cell Type	LFP
Rated Power	5.12kWh
Rated Capacity	100Ah
Rated Voltage	51.2V
Charge Voltage	57.2V
Max Charge/Discharge Current	100A
Discharge Peak Current	105A / 15s, 150A / 0.5s
Parallel	Up to 32 units parallelable w/o extra device needed, slave battery drops online or come back alive does not affect system running
IP Level	IP65
Dimension	500*650*167mm
Weight	60Kg
Communication	CAN/RS485
Compatible Inverter	Victron, Luxpower, Deye, Voltronic, SMA Goodwe, Growatt, Sofar, Solark, SRNE, Must
Humidity	5%~85% RH (No condensation)
Work Temperature	-20°C~ +55°C, heating system built-in
Storage Temperature	-10°C~ +35°C
Remote Maintenance	Handy monitor & flexible remote upgrade, Original firmware backup to prevent upgrade failure
Warranty *	10 years, 6000 cyclesA
Certification	CE UN38.3, IEC62619
Protection	Over charge/discharge/current/voltage/temperature protection Short circuit protection, Reverse connection protection Charge balance, Low SOC protection



# Battery Storage

## PSTACK

- 8 Series per stack
- 20 Stack parallel
- 10 years warranty
- Ultra safe LFP material
- Short circuit protection
- Flexible remote upgrade
- Wide range inverter compatibility
- High Voltage battery

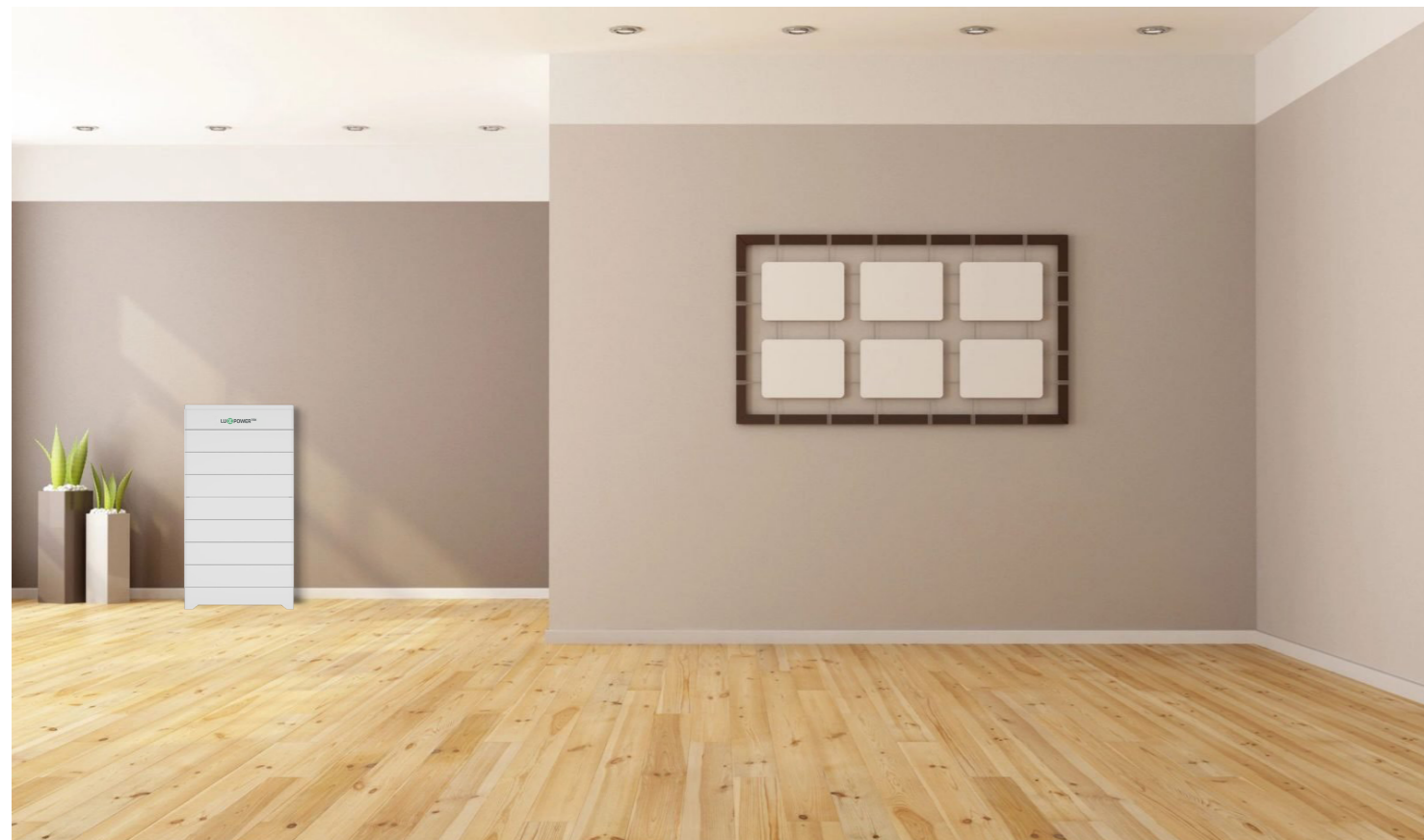

# Specifications

Your Reliable Energy Solution Partner

Model	PSTACK							
Scalable Connection	2 ~ 8pcs series per stack, up to 20 stack parallel							
Battery module nominal voltage	70.4V							
Battery module nominal capacity	72Ah							
Battery module nominal energy	5.069kWh							
Protection	IP65							
Battery module voltage range	61.6V~80.3V							
Recommend charge/discharge current	36A, 0.5C per battery module							
Max continuous charge/discharge current	50.4A, 0.7C per battery module							
Max continuous charge/discharge power	3.548 kW per battery module							
Max. series number per cluster	8 series							
Cluster parallel	Up to 20 clusters, without extra unit needed							
Battery stack nominal energy	10kWh	15kWh	20kWh	25kWh	30kWh	35kWh	40kWh	
Voltage	140.8V	211.2V	281.6V	352V	422.4V	492.8V	563.2V	
Weight	110Kg	155Kg	200Kg	245Kg	290Kg	335Kg	380Kg	
Dimension(W*D*H mm)	736*382*577	736*382*735	736*382*893	736*382*1051	736*382*1209	736*382*1367	736*382*1525	
Charging/Discharging temperature	0 ~ +55 °C, -20 ~ +55 °C							
Recommend storage temperature	-10 ~ +35 °C (Max. range -30 ~ +55 °C)							
Recommend storage humidity	10% ~ 90% RH							
Warranty *	10 years, 6000 cycles							
Certification	CE UN38.3; IEC62619							
Remote Maintenance	Flexible remote upgrade, Original firmware backup to prevent upgrade failure							

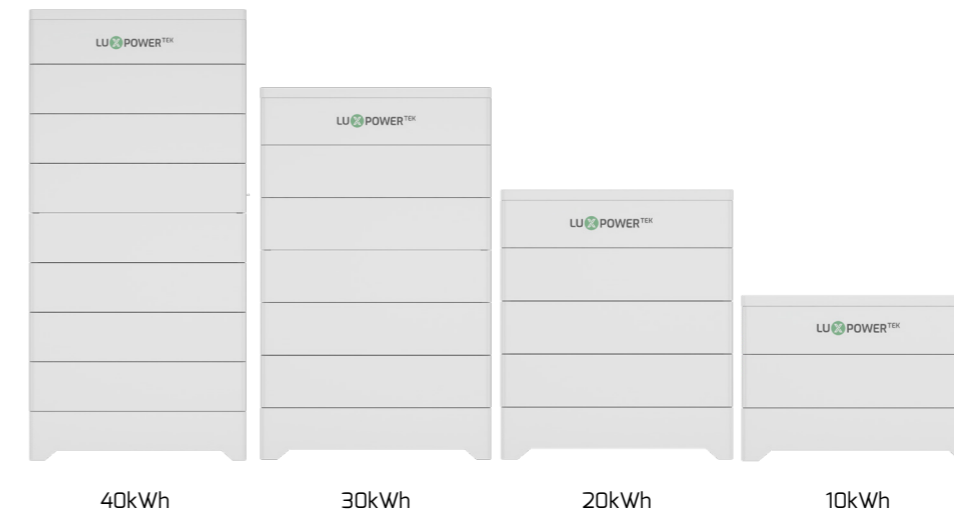

# MONITORING APP/WEB

# Top Energy Storage App

# Intelligent Power Management System

For APP Download



Android



IOS

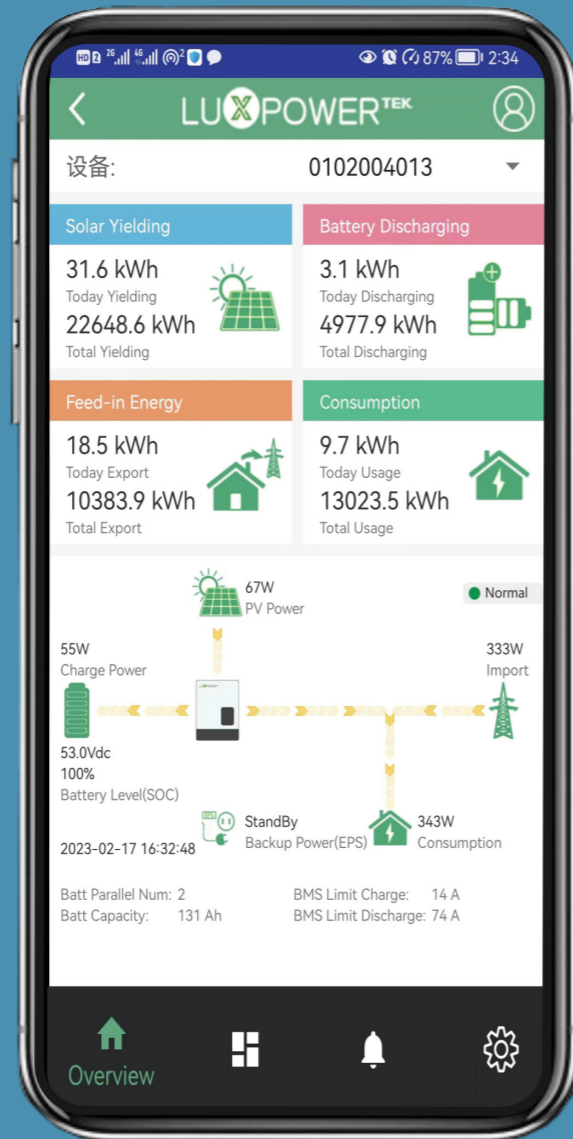

Luxpower has dedicated to making things easier since day 1. Thanks to the greatly accessible monitor and manager, all needs from users, installers, and distributors can be met.



C501, Building A, Donghua Industrial Park,  
5003 Bao'an Avenue, Sanwei Community,  
Hangcheng Street, Bao'an District,  
Shenzhen, 518126, China.



+86 0755 8520 9056  
www.luxpowertek.com  
info@luxpowertek.com

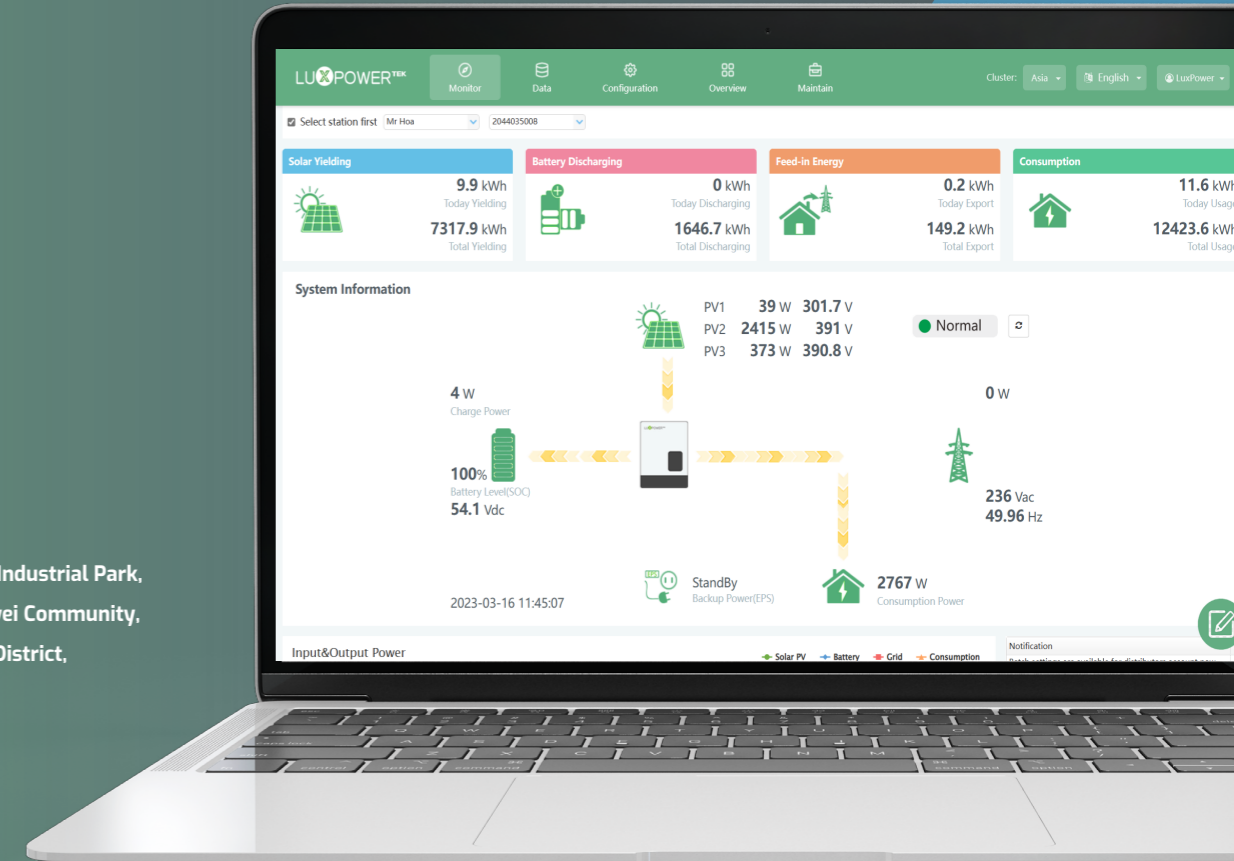

# Certificates

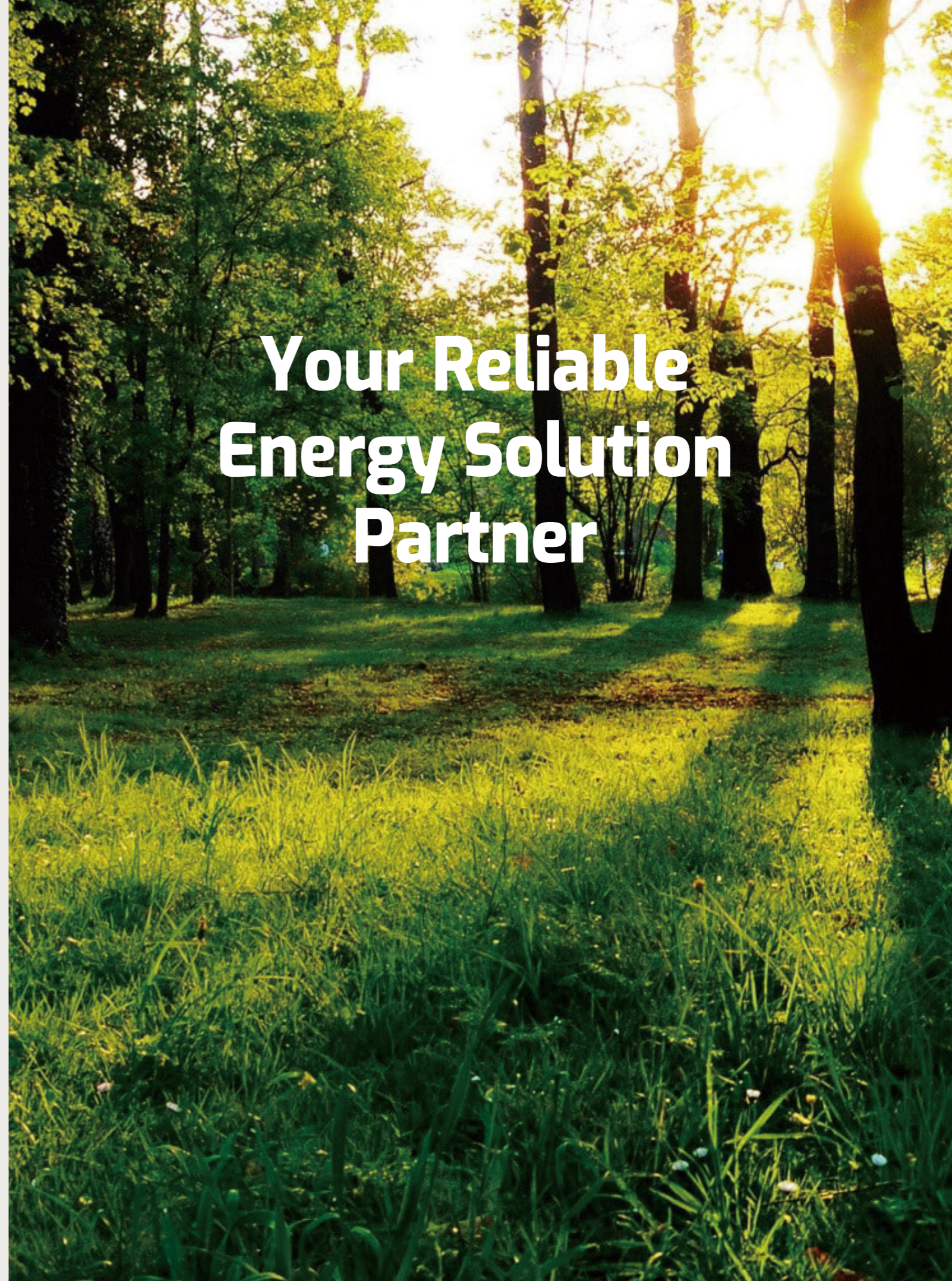

# Your Reliable Energy Solution Partner