

Hybrid inverter User Manual

GEN-LB-EU 7-10K

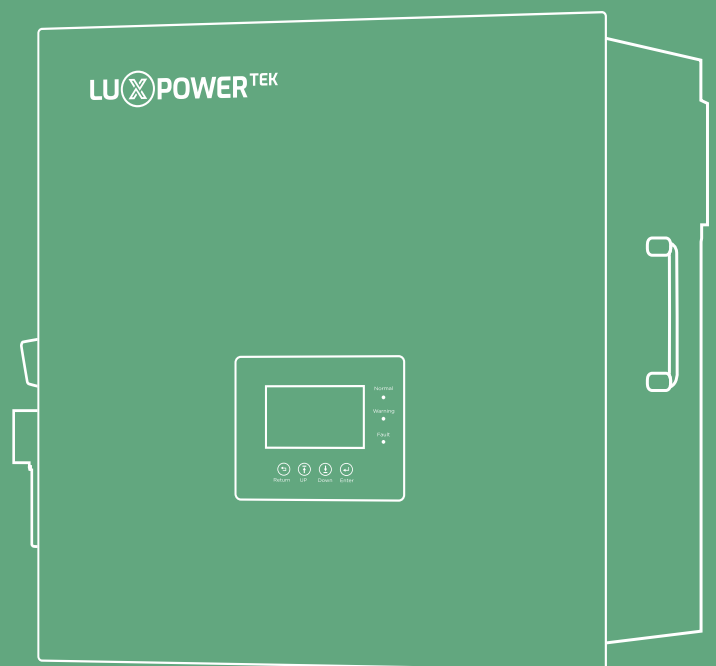

LUX POWERTEK

Copyright© 2024 Lux Power Technology Co., Ltd. All Rights Reserved. This manual, protected by the copyright and intellectual property rights of Lux Power Technology, may not be modified, copied, or reproduced without prior written permission. Brands and trademarks mentioned belong to their respective owners. Read carefully for product reliability and warranty eligibility. For warranty details, refer to Lux Power Technology Limited Warranty. Intended for professional service providers; no statements constitute an express or implied warranty.

Descriptions may contain predictive statements; differences may occur. Provided for reference, subject to change without notice by Lux Power Technology.



Website



YouTube



Facebook

 www.luxpowertek.com



Scan to download

Table Of Contents

About This Manual	1
1. Safety	1
1.1 Safety Instruction	1
2. Brief Introduction	4
2.1 System Solution	4
3. Installation	5
3.1 Packaging List	5
3.2 Location Selection and Installation	6
3.2.1 Requirements for installation location	6
3.2.2 Installing the inverter	7
3.3 Connection Overview	9
3.3.1 System connection	9
3.4 PV Connection	11
3.5 Battery Connection	13
3.5.1 Battery power cable connection	13
3.5.2 Battery communication cable connection	15
3.6 Grid&EPS load Connection	16
3.6.1 Grid type selection	16
3.6.2 Grid and EPS load connection for single-phase service	16
3.6.3 AC cable connection	17
3.6.4 CT/Meter connection	19
3.7 Working with Generator	21
3.7.1 Generator system connection	21
3.7.2 Generator Startup and stop settings	23
3.8 AC Coupling Installation Connection	23
3.9 Parallel System Connection	25
3.9.1 Connection for paralleling system	25
3.10 Monitor System Setup	28

3.10.1 Wifi/2G/4G/WLAN dongle connection28

3.10.2 Setup the Monitor system29

3.10.3 Set homewifi password to dongle30

3.10.4 Third party RS485 communication31

4. Operation Guide32

4.1 Operation Mode32

4.1.1 Self-usage mode (Default)32

4.1.2 Charge first mode33

4.1.3 AC charge mode34

4.1.4 Grid peak-shaving Function34

4.1.5 Smart load Function35

4.2 LCD Display35

4.2.1 Viewing information and alarm/fault record35

4.2.2 Setting parameters37

4.3 Start-up and shut down the inverter40

4.3.1 Start up the inverter40

4.3.2 Shut down the inverter40

5. Troubleshooting & Maintenance40

5.1 Regular Maintenance40

5.2 LED Displays41

5.3 Troubleshooting Based on LCD Displays41

5.4 Fan replacement41

Revision History

Version	Date	Description
UM-GEN02002	2024.07.04	First official release.

1. Safety

1.1 Safety Instruction

General Safety Instructions

The inverter has been designed and tested strictly according to international safety regulations. Read all safety instructions carefully prior to any work and observe them at all times when working on or with the inverter. The operator must be qualified personnel and the installation must be capable with relevant national or international standards or regulations.

Incorrect operation or work may cause:

- injury or death to the operator or a third party
- damage to the inverter and other properties belonging to the operator or a third party.

Important Safety Notifications

There are many safety issues need to be carefully notified before, during and after the installation, and also in future operation and maintenance, following is important safety notifications to operator, owner and user of this product in appropriate usage.

DANGER

Dangers of High Voltages and Large Current

- Beware of high PV voltage. Please turn-off the DC switch of PV Panel output before and during the installation to avoid electric shock.
- Beware of high grid voltage. Please turn-off the AC switch of grid connection before and during the installation to avoid electric shock.
- Beware of large current of the battery output. Please turn-off the battery module before and during the installation to avoid electric shock.
- Do not open the inverter when it's working to avoid electric shock and damages from live voltage and current from the system.
- Do not operate the inverter when it's working, only the LCD and buttons can be touched in limited cases by qualified personnel, other parts of the inverter can be touched when the inverter is under a safe state (e.g. fully shut-down).
- Do not connect or disconnect any connections (PV, battery, grid, communication etc.) of the inverter when it's working.
- Make sure the inverter is well grounding, an operator should make sure himself is good protected by reasonable and professional insulation measurements (e.g. personal protective equipment (PPE)).
- Inspect relevant existed wiring on-site of the installation is under good condition before installation, operation or maintenance.
- Inspect the connections are good between inverter and PV, battery and grid during installation to prevent damages or injuries caused by bad connections.

⚠ WARNING**Avoid Misoperation and Inappropriate Usage**

- All the work of this product (system design, installation, operation, setting, configuration and maintenance must be carried out by qualified personnel as required.
- All connections must be in accordance with local and national regulations and standards.
- Only when permitted by utility grid, the inverter and system can interconnected with the utility grid. All the warning labels or nameplates on the inverter must be clearly visible and must not be removed, covered or pasted.

The installation should choose a right position and location as required in this manual with

- consideration to safety of users' in future operation.

Please keep the children away from touching or misoperation the inverter and relevant system.

- Beware of burning hurt, the inverter and some parts of the system could be hot when working,
- Beware of burning hurt, the inverter and some parts of the system could be hot when working, please do not touch the inverter surface or most of the parts when they are working. During inverter is in working, only the LCD and buttons could be touched.

● NOTICE

- Please carefully read this manual before any work carried out on this inverter, after the installation, please keep this manual carefully stored and easy to access at any time.
- Qualified personnel must undergo training in electrical system installation and commissioning, including hazard management. They should possess knowledge of the manual and related documents. Installers or operators are expected to be regulations and directives.

2. Brief Introduction

2.1 System Solution



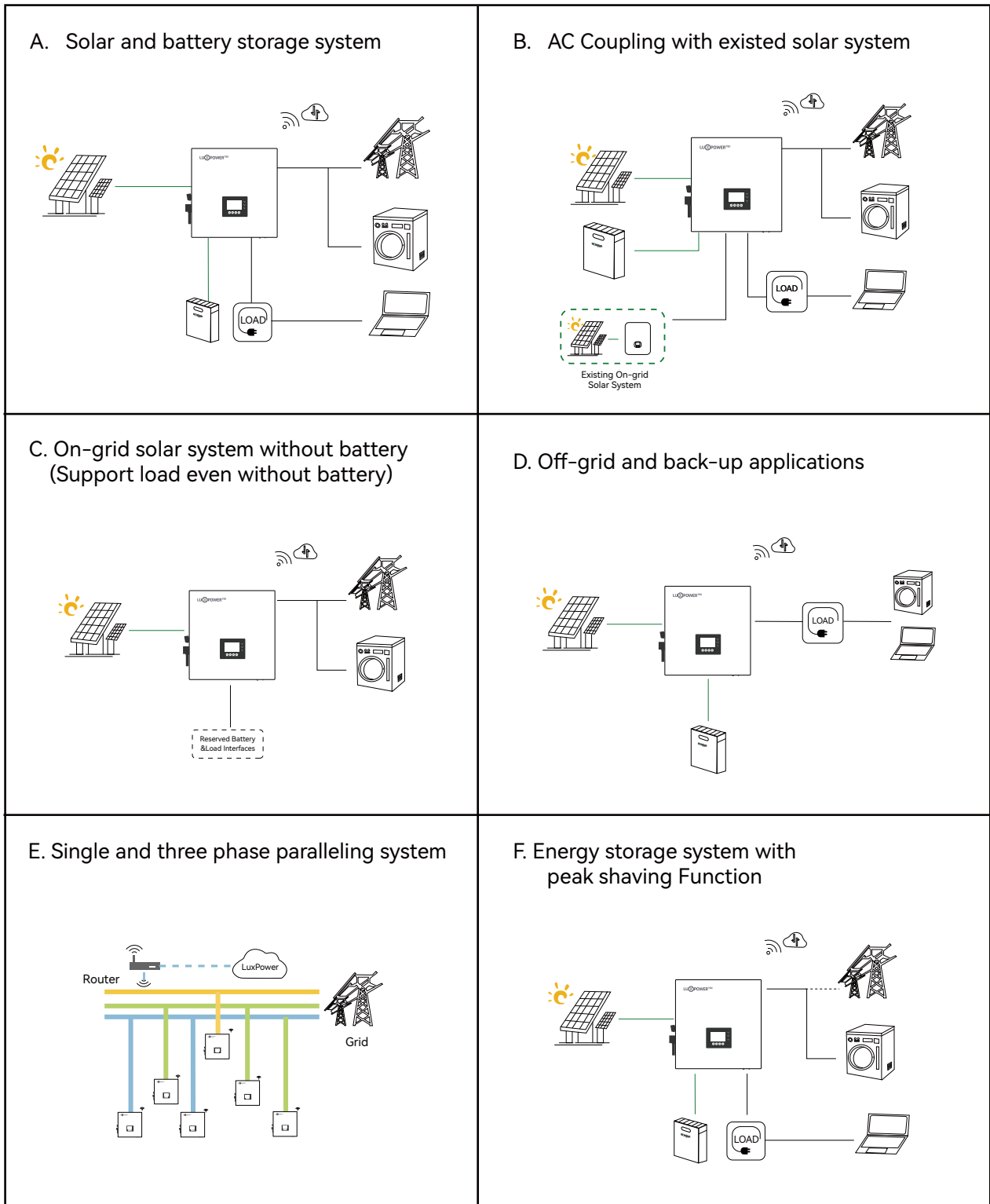



















This product and relevant system is suitable for following system applications (system diagram):



3. Installation

3.1 Packing List

Before installation, please inspect the unit. Be sure that nothing inside the package is damaged. You should have received the following items in the package:

 Hybrid Inverter X 1	 User Manual X1	 RJ45 Terminal X 4	 Wi-Fi Module X1	 Communication Port Cover X 1	 Expansion Screw X 4
 Wall-mounted X 1 bracket		 Disassembly Tool (for connector)	 Cross Head Screw X 13	 PV Connector X 12	
 PV Terminal Male Core	 PV Terminal Female Core	 4mm Allen Key	 3mm Allen Key	 Battery Terminal Accessories	 CT
 Battery Communication cable L= 2m X 1(Orange)	 Parallel Communication cable L=2m X 1(grey)	 Battery Connector Waterproof Cover	 Grid Connector	 EPS Connector	 GEN Connector

3.2 Location Selection and Installation

3.2.1 Requirements for installation location

- a. The wall for mounting should be strong enough to bear the weight of inverter.
- b. Please maintain the minimum clearances below for adequate heat dissipation.

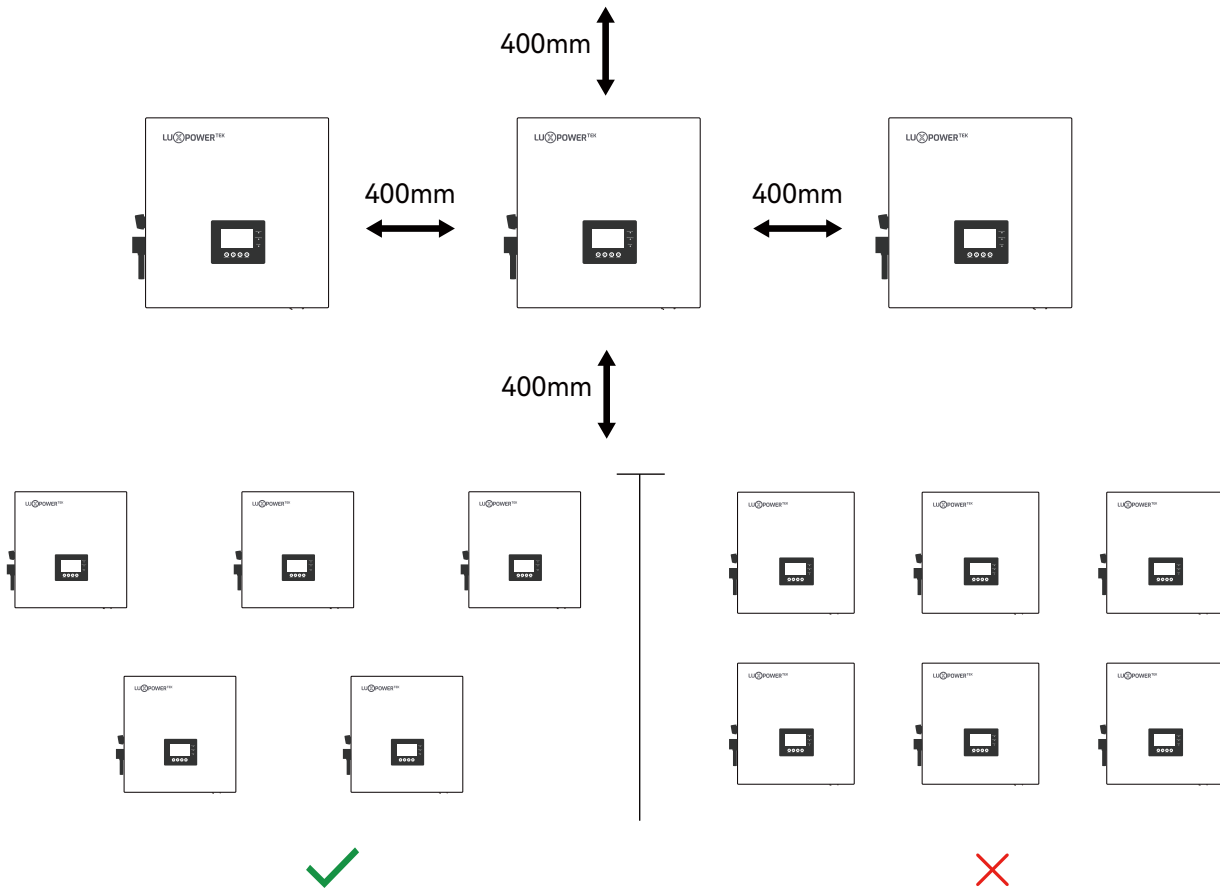

- c. Never install the inverter in a place with direct sunlight, rain or snow. Please refer to below figure and select a well shaded place or install a shed to protect the inverter from direct sunlight, rain and snow etc. Protect the LCD screen from excessive UV exposure

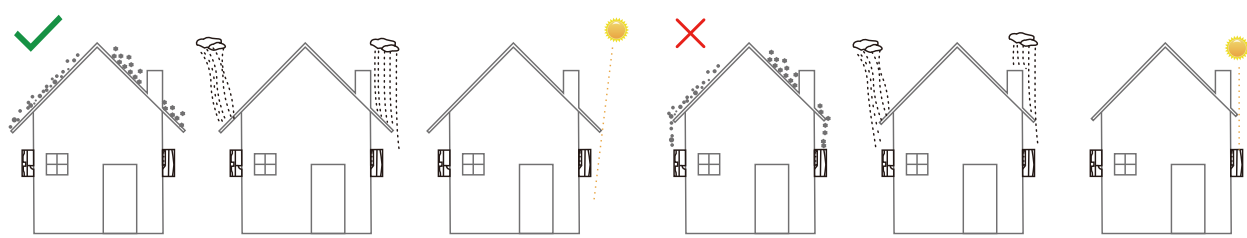

d. The inverter should be installed upright on a vertical surface.

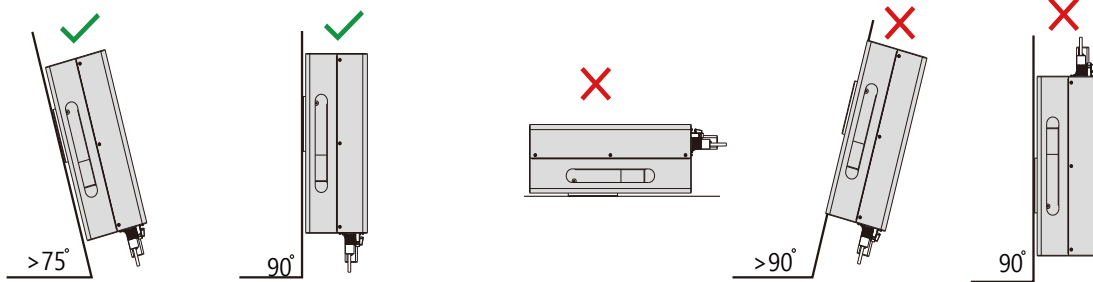

3.2.2 Install the inverter

The inverter is wall-mounted type, should be installed on a vertical, solid mounting surface, such as wood studs, brick or concrete wall. Two or more persons may be needed to install the inverter due to its weight.



The mounting steps are as below: (Use brick wall as example)

Step 1. Mark the positions of drill holes with the mounting bracket, then drill 4 holes of 8mm (5/16inch) diameter and make sure the depth of the holes is deeper than 50mm(2inch).

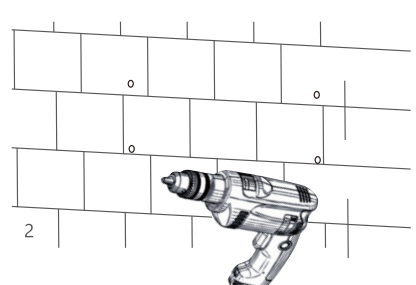
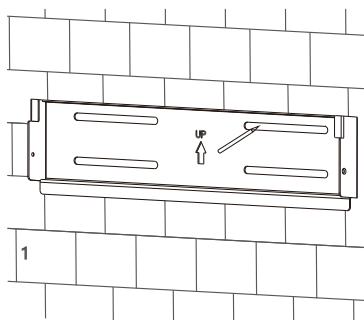

Step 2. Install the expansion bolts into the holes and tighten them, then use the corresponding nuts and washers (packaged together with the expansion bolts) to install and fix the wall-mounting bracket on the wall

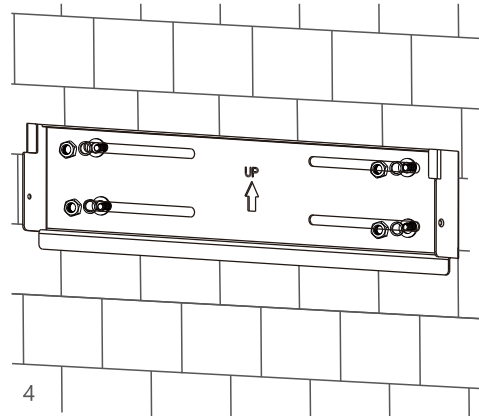
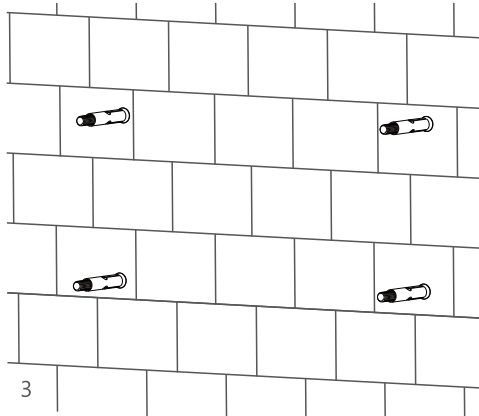

Step 3. Hang the inverter onto the wall-mounting bracket and lock the inverter on the wall using 2 self-tapping screws on the top of the inverter.

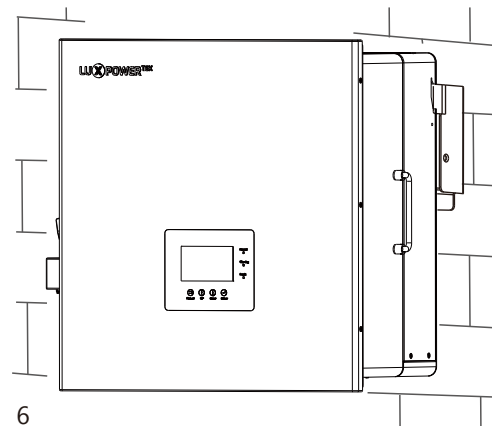
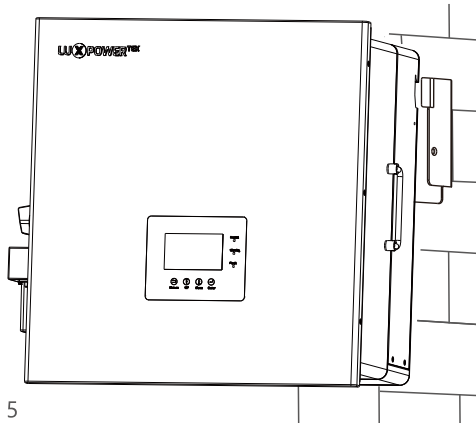

For installation on wood studs

Fasten the mounting bracket on the studs with 4 wood screws, then hang the inverter onto the bracket and lock the inverter on the wall with 2 self-tapping screws.

Please note that the wood screws and self-tapping screws are not provided with the inverter. Installers need to prepare the screws before installation. (Use brick wall as example)

3.3 Connection Overview

3.3.1 System Connection

The system connection diagram is as below:

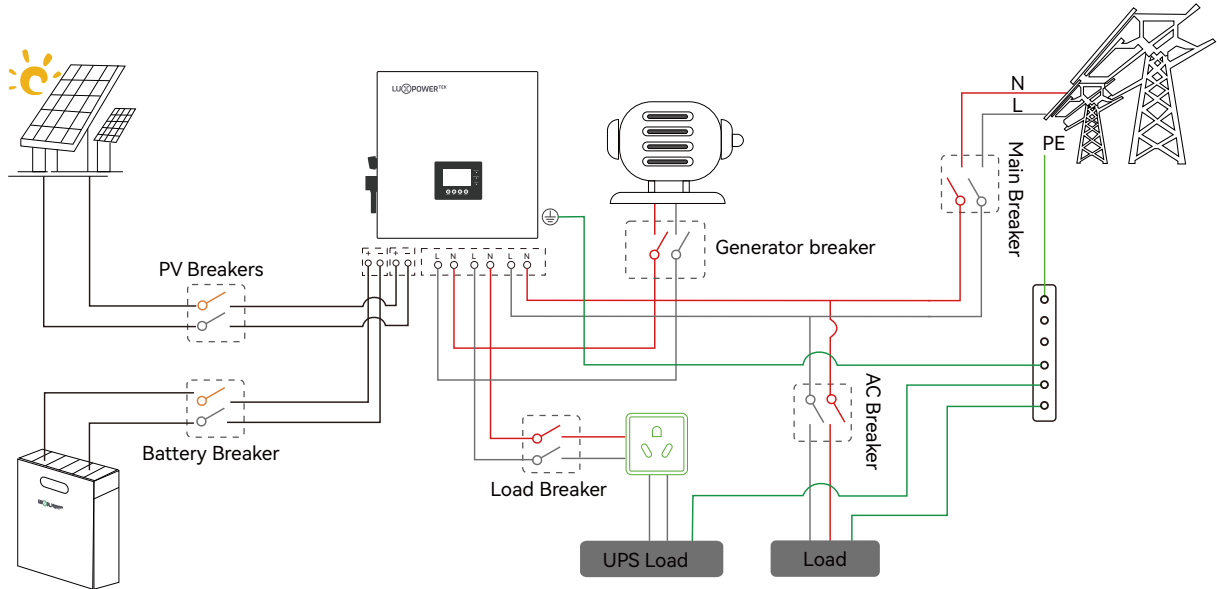

Please prepare the breakers before connection, breakers selection recommendation for both DC and AC

Inverter model	7K	8K	10K
PV Breakers(2Px4)	MPPT1 string 1: 600V/20A MPPT1 string 2: 600V/20A MPPT2 string 1: 600V/20A MPPT2 string 2: 600V/20A	MPPT1 string 1: 600V/20A MPPT1 string 2: 600V/20A MPPT2 string 1: 600V/20A MPPT2 string 2: 600V/20A	MPPT1 string 1: 600V/20A MPPT1 string 2: 600V/20A MPPT2 string 1: 600V/20A MPPT2 string 2: 600V/20A
Battery Breaker(2P)	100V/300A	100V/300A	100V/300A
Main Breaker(2P)	100A/230Vac	100A/230Vac	100A/230Vac
Load Breaker(2P)	63A/230Vac	63A/230Vac	63A/230Vac
Generator Breaker	63A/230V	63A/230V	63A/230V

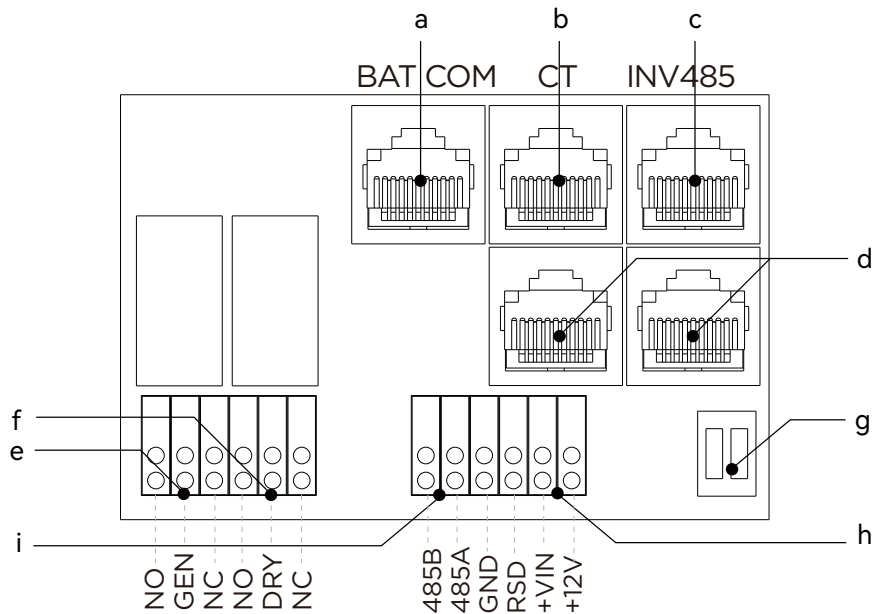
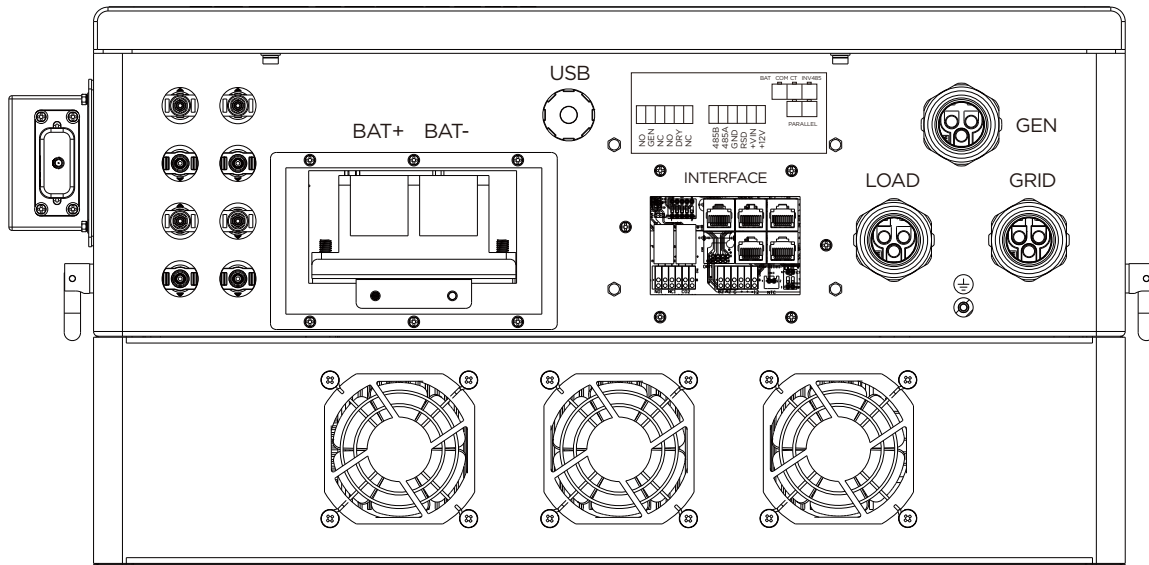

a	Battery communication port(CAN&RS485) please check Chapter 3.5.2 for Pin definition
b	CT port: please check Chapter 3.6.4 for CT connection
c	INV 485: Debugging port
d	Parallel communication port please check Chapter 3.9 for Parallel connection
e	GEN(NO, NC): Connection for generator auto-start function
f	DRY(NO,NC): reserved
g	CAN Matching resistance: Set DIP switch when use inverters in parallel
h	VIN/+12V: Connect an outside emergency switch on these 2 terminals
i	Meter 485B&485A: For Meter communication

3.4 PV Connection

PV connection of this hybrid inverter is same as traditional on-grid solar inverter (string inverter).

WARNING

* Please check the lowest ambient temperature of the location of the installation. The rated Voc on solar panel nameplate is obtained at 25°C. Solar panel Voc will increase with the decreasing of ambient temperature. Please ensure the Max.solar string voltage corrected at the lowest temperature not exceed the inverter max input voltage 550V for safe.

NOTICE

1. The inverter has two MPPTs. Both MPPT1 and MPPT2, users can connect 2 strings.
2. When users connect 2 strings to MPPT, make sure the two strings has same quantity of solar panels. The inverter will limit the total MPPT1 and MPPT2 input current to 25A/25A.
3. The inverter will limit the max. solar input power to 15kW for 10k model and 12kW for 7k and 8k model totally.

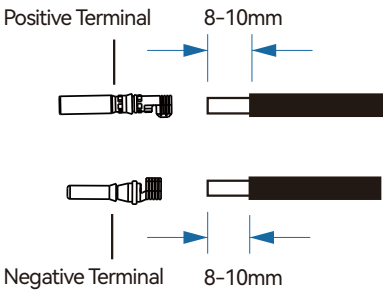
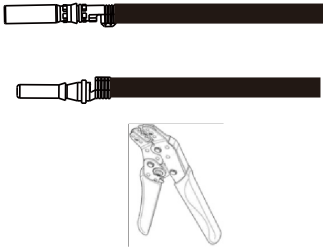
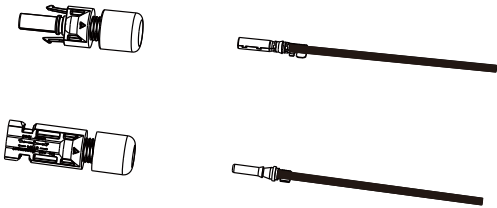
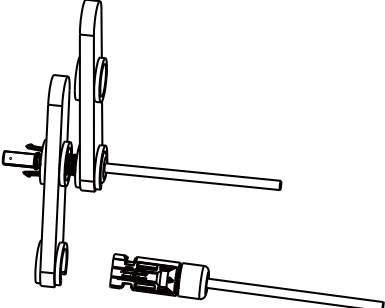
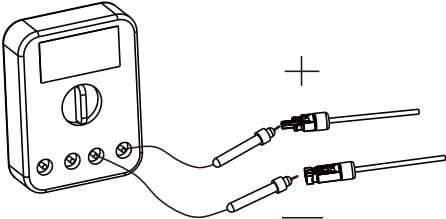
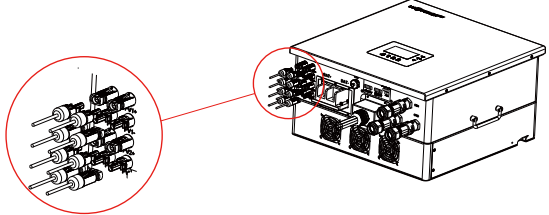
Cable Conductor Cross-Sectional Area	Cable model	Cable Voltage Withstand Requirements
5-9mms	10-8AWG	600V
<p>1. Strip the cable insulation and install cold-pressed terminals</p> 		<p>2. Use a crimping tool to connect the terminals, ensuring that the cable cannot be pulled out after crimping.</p> 
<p>3. Assemble the cable into the positive and negative terminal casings, ensuring a secure connection.</p> 		<p>4. Tighten the sealing nut</p> 
<p>5. Check the polarity of the photovoltaic string cables and ensure that the maximum voltage does not exceed 1000V.</p> 		<p>6. Ensure that all DC switches are in the "OFF" position and then insert the PV connector into the corresponding PV terminal in the inverters PV input terminal area.</p> 

3.5 Battery Connection

3.5.1 Battery power cable connection

This part in this manual only describe the battery connection on Converter side, should you need more detailed information regarding the battery connection on battery side please refer to the manual of the battery.

Cable Requirement:	
Cross-section	35mm ² ×2 or 50mm ² ×1

● NOTICE

- Make sure that the converter is powered off and there is no residual voltage at the battery interface. If the battery side line is connected, make sure that the battery is off.
- When the battery is charging and discharging, the current is big, please be sure to tighten the connection screws.
- Note that if there is a switch connected between the converter and the battery, make sure that the switch is in the off state.
- Please note that there is a large current from the battery to the converter, so it is recommended that the installation distance is not too far.

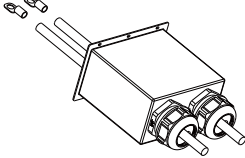
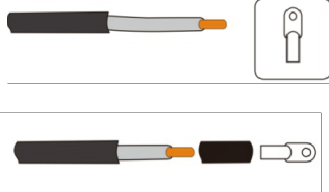
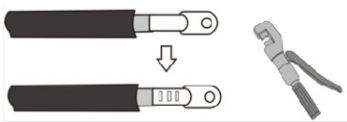
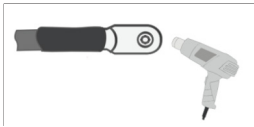
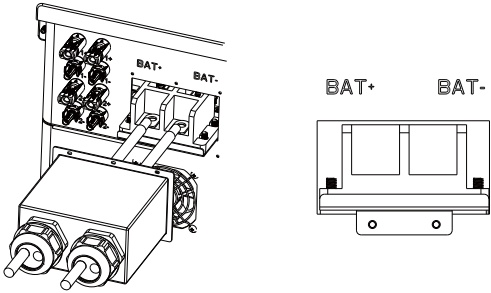
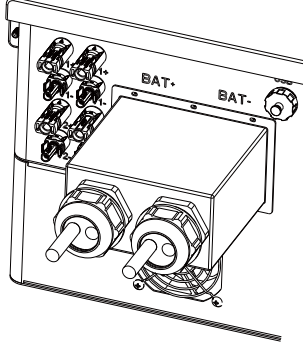
<p>1. Unscrew the terminal head of the waterproof cover and pass the battery cable through the waterproof head and waterproof cover.</p> 	<p>2. Strip the insulation of the cable, install heat shrink tubing and OT/DT terminal.</p> 
<p>3. Press the DT terminal sleeve wire barrel with hydraulic pliers to ensure that the wire and the terminal are firmly connected.</p> 	<p>4. Use a heat gun to fix the heat shrink tube.</p> 
<p>5. Fix the cables to the corresponding terminals according to the positive and negative polarities of the battery side (be sure to connect according to the correct polarity, reverse connection will cause damage to the converter and battery.)</p> 	<p>6. Tighten the sealing nut of the waterproof head.</p> 

3.5.2 Battery communication cable connection

A correct battery communication cable must be used to connect the battery to the inverter when users choose lithium-ion battery type. Please select 'Lead-acid' type if the lithium battery can not communicate with inverter. The battery communication port on inverter is a RJ45 socket, Pin for the RJ45 plug of the communication cable is as below. Make the communication cable according to the below inverter Pin and the correct pinout of communication port on battery. The inverter supports both CAN and RS485 communication.

If using a Luxpower battery, select lithium type for option 6: Luxpower; for Hina battery, select lithium type option 1: Hina Battery.

Pin	Description
1	NC
2	GND
3	NC
4	BAT CAN H
5	BAT CAN L
6	NC
7	BAT RS485 A
8	BAT RS485 B

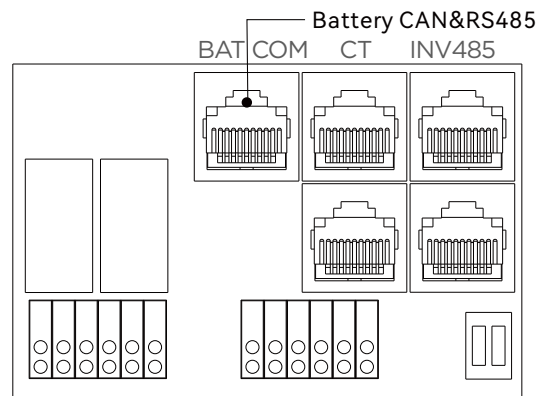

After connecting the battery power cable and communication cable, users are required to access the Advanced settings menu on the inverter LCD screen to select the battery type and brand.

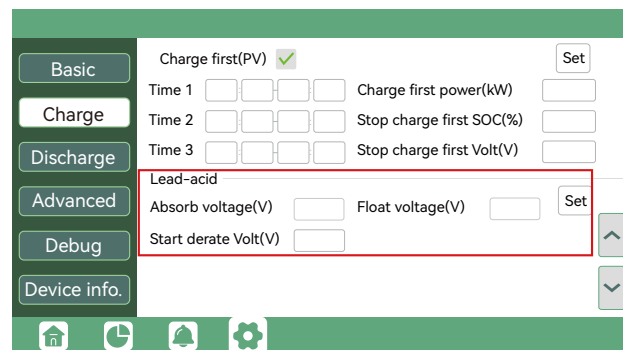
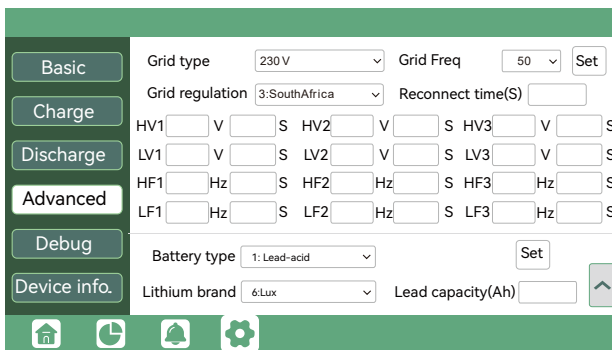

NOTICE

For Li-ion battery

1. Please make sure the lithium-ion battery to be used is compatible with inverters. Please contact your distributor for an updated battery compatible list.
2. If you are using multiple battery modules with the inverter, the inverter communication cable must be connected to the primary battery. Please check with your battery supplier for battery primary and subordinate settings.

For Lead-acid battery

1. The temperature sensor for the lead-acid battery is optional. If you need it, please contact the distributor for purchasing.
2. There are three stages for lead-acid battery charging. For charging/discharge related parameters, please check the charge /discharge settings page.

3.6 Grid & EPS load Connection

3.6.1 Grid regulation selection

Our inverters are compliant with on-grid regulations in several areas, including standards such as NRS097, G98, G99, and more. When making the selection, please ensure alignment with the specific regulations in your area.

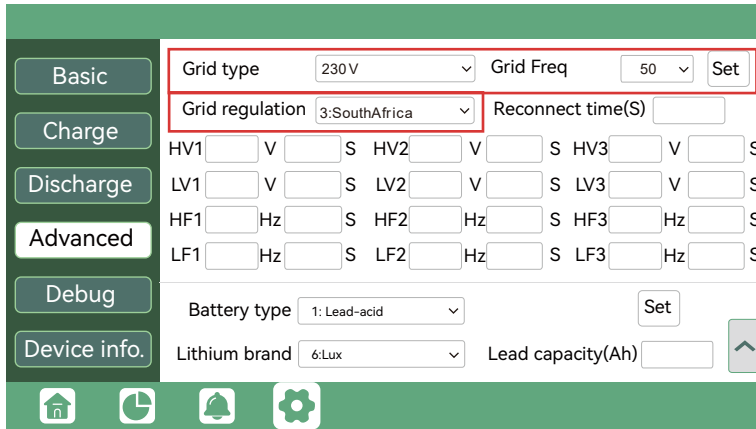

3.6.2 Grid and EPS load connection

The inverter can be connected to the load side of the service disconnecting means if the busbar rating in the main panel can meet the NEC705.12(B)(3) requirements. Otherwise, a Line side connection can be made to avoid an expensive main panel upgrade.

Grid and EPS Load Connection

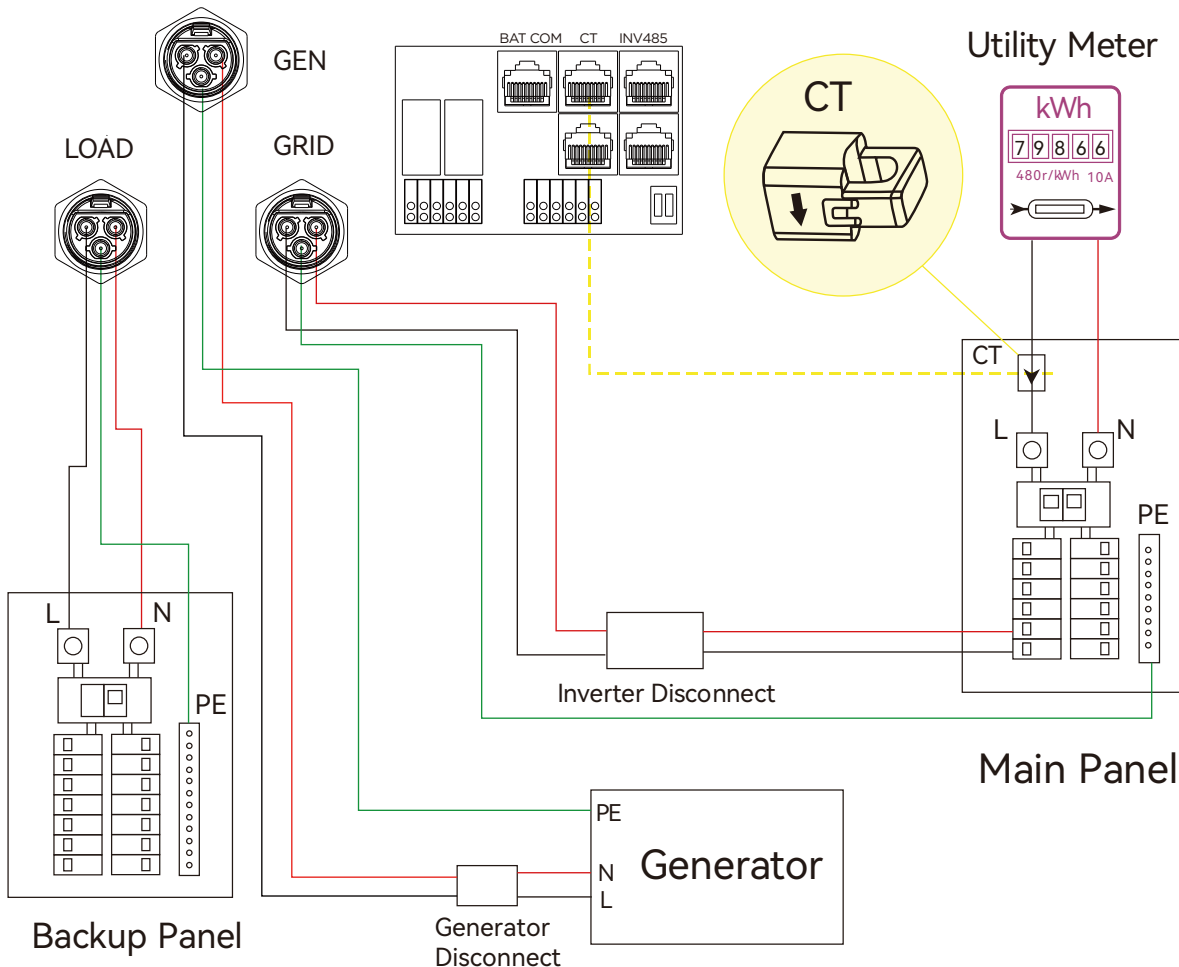

3.6.3 AC cable connection

Cable Requirement:

Cable Size	Minimum Voltage
9-7 AWG(6-10mm)	600V

Step 1: Installation of Grid Connector

Component Overview

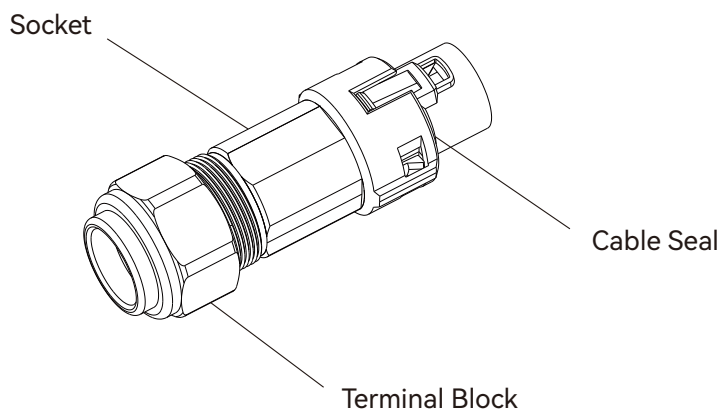

- a) Thread the AC cable through the cable seal and socket. Insert the conductors fully into the corresponding terminals of the terminal block and tighten the screws.

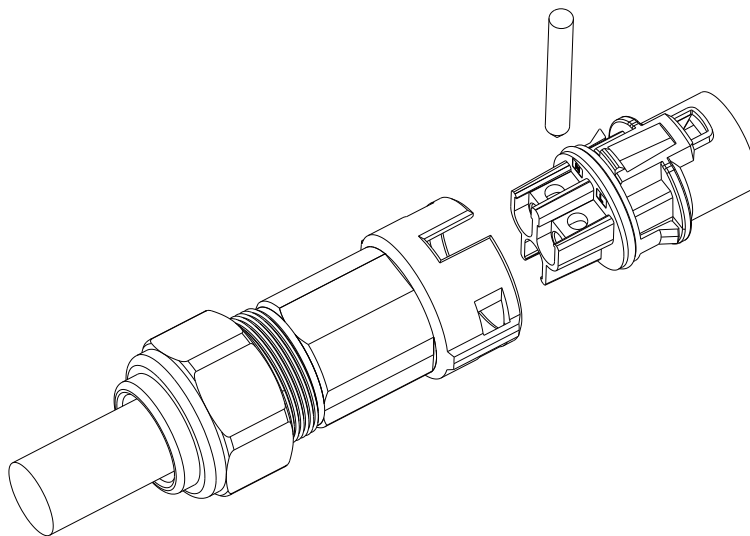

b) Refer to the image to ensure correct AC cable connection.

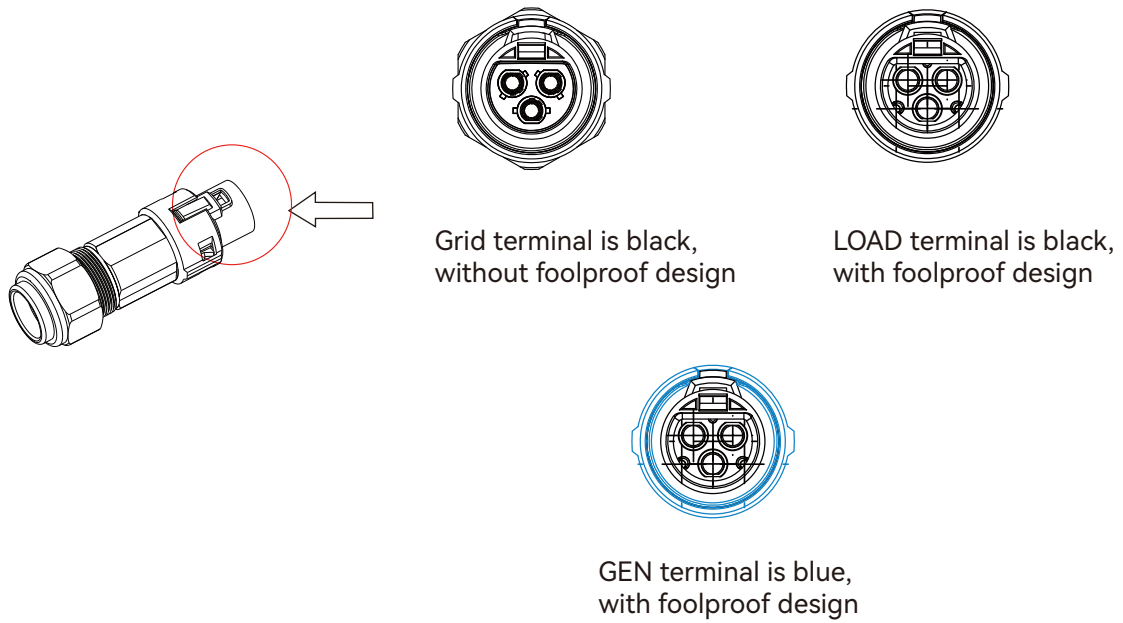

c) Assemble the Grid connector, ensuring that the ribs of the terminal block and the grooves on the housing are fully engaged until you feel or hear a distinct “click”.

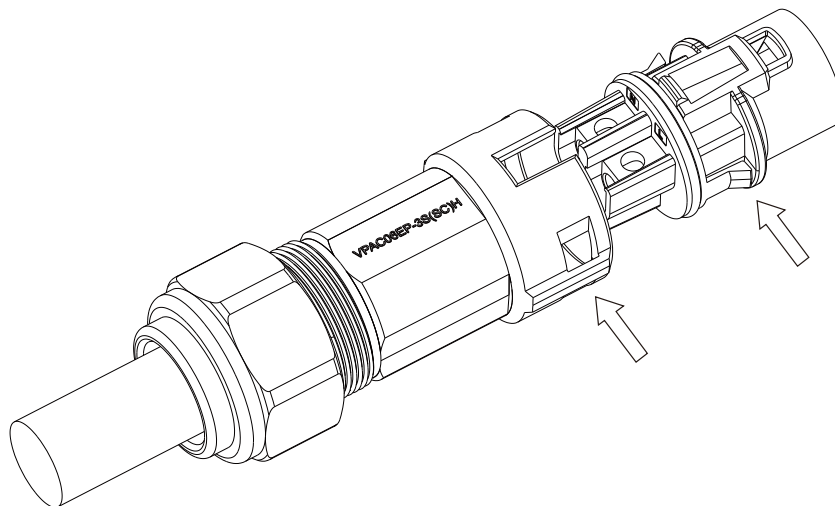

Step2: Installation of LOAD Connector

- a) Align the LOAD connector with the AC terminals, and manually engage them until you hear or feel a distinct “click”.
- b) Install an AC circuit breaker (AC switch) between the inverter and the grid. Before connecting the AC cable from the inverter to the AC circuit breaker, ensure the AC circuit breaker is functioning properly. Close the AC circuit breaker and leave it in the open position.
- c) Connect the PE conductor to the grounding pole, and connect the N and L conductors to the AC circuit breaker.
- d) Connect the AC circuit breaker to the AC grid.
- e) Install a separate single-phase circuit breaker or other load disconnection device for each inverter to ensure safe disconnection under load.

● NOTICE

The inverter features residual current detection and protection functions. If the inverter must be equipped with an AC circuit breaker with residual current detection capability. An AC circuit breaker with a rated residual current greater than 300mA must be selected.

3.6.4 CT/Meter Connection

- 1. A single CT or single-phase meter needs to be installed
- 2. Standard provides a pair of CT

CT Port Pin definition

The CT port for a pair of CTs connection is a RJ45 port, we have made a RJ45 plug on those a pair of CTs in Charge Vpv start (V) CT ratio advance, so you can connect it to port directly

Pin	Description
1-4	reserve
5	PV CT N
6	PV CT P
7	Grid CT N
8	Grid CT P

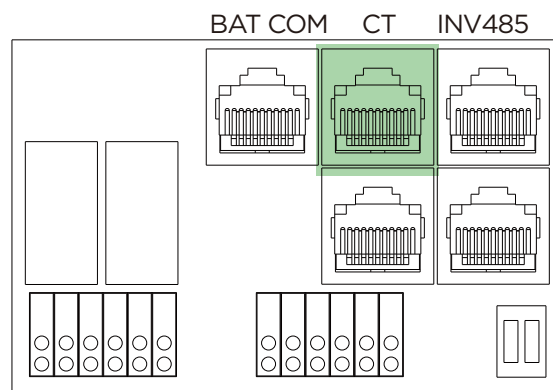

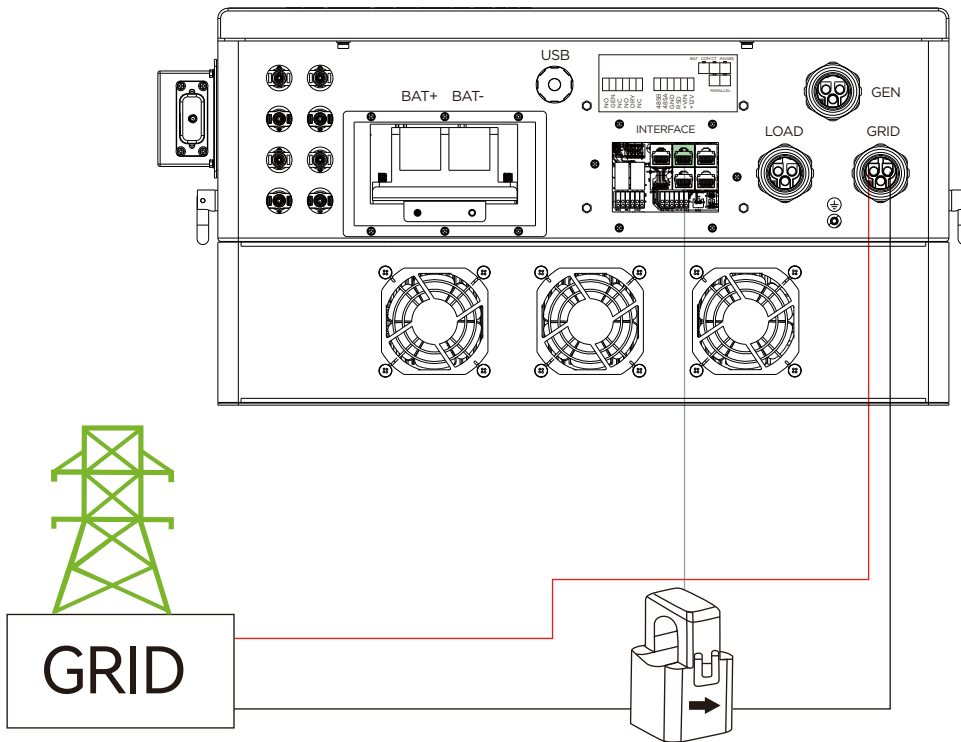

Please refer to the above connection diagram for the correct positions of CTs. The arrows on the CTs must point to inverter side.

CT Clamp Ratio

The Luxpower inverters support two ratios of CT clamp-1000:1 and 3000:1. The CT ratio of the CTs in the accessory bag is 1000:1. If you are using a 3rd party CT, please ensure the CT ratio is either 1000:1 or 3000:1 and then select the correct CT ratio setting in the inverter monitor page or on inverter LCD.

Extend CT clamp cable

3.6.4 CT/Meter Connection The CT wires can be extended with a common ethernet cable if the length is not enough. A RJ45 adapter is needed for the extending. The CT wires can be extended up to 300ft(around 100m).

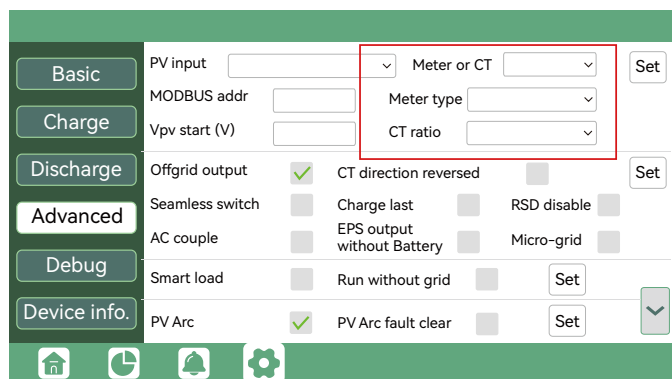
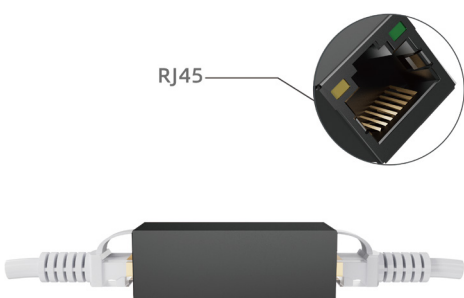

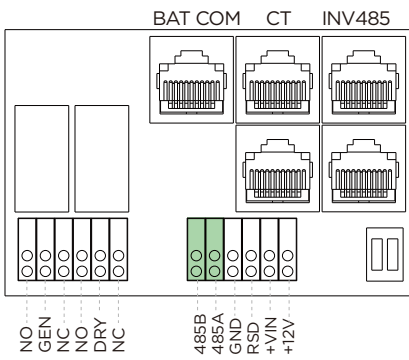

Meter Connection

Currently only EASTRON SDM630-Modbus meters can be used. If you need to use meter for import/export detection instead of CTs, you need to connect it to the Meter 485A and 485B terminals on the inverter, please contact Luxpowertek for detailed guideline.

3.7 Working with Generator

3.7.1 Generator system connection

This hybrid inverter can work with generator. There are Gen port on the inverter for generator connection.

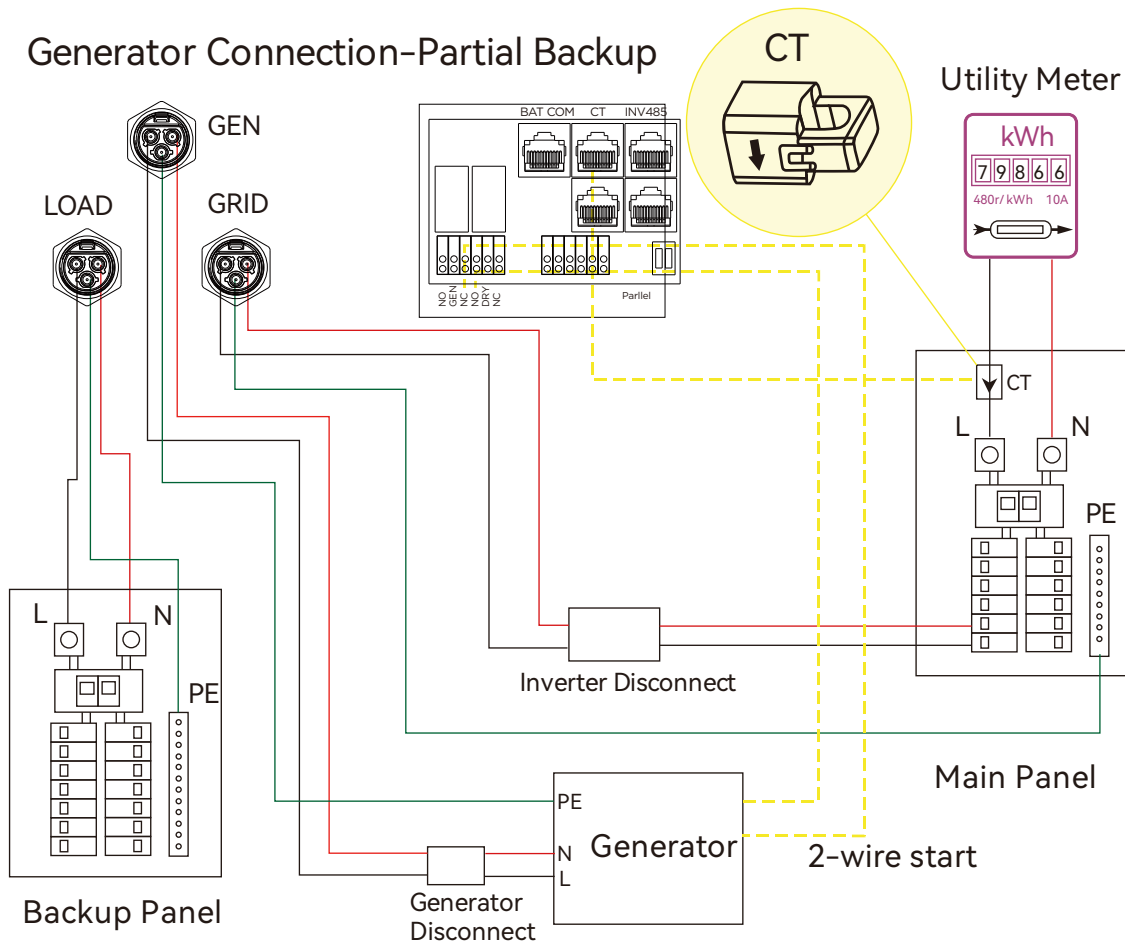

Generator Connection-Power Cut Backup

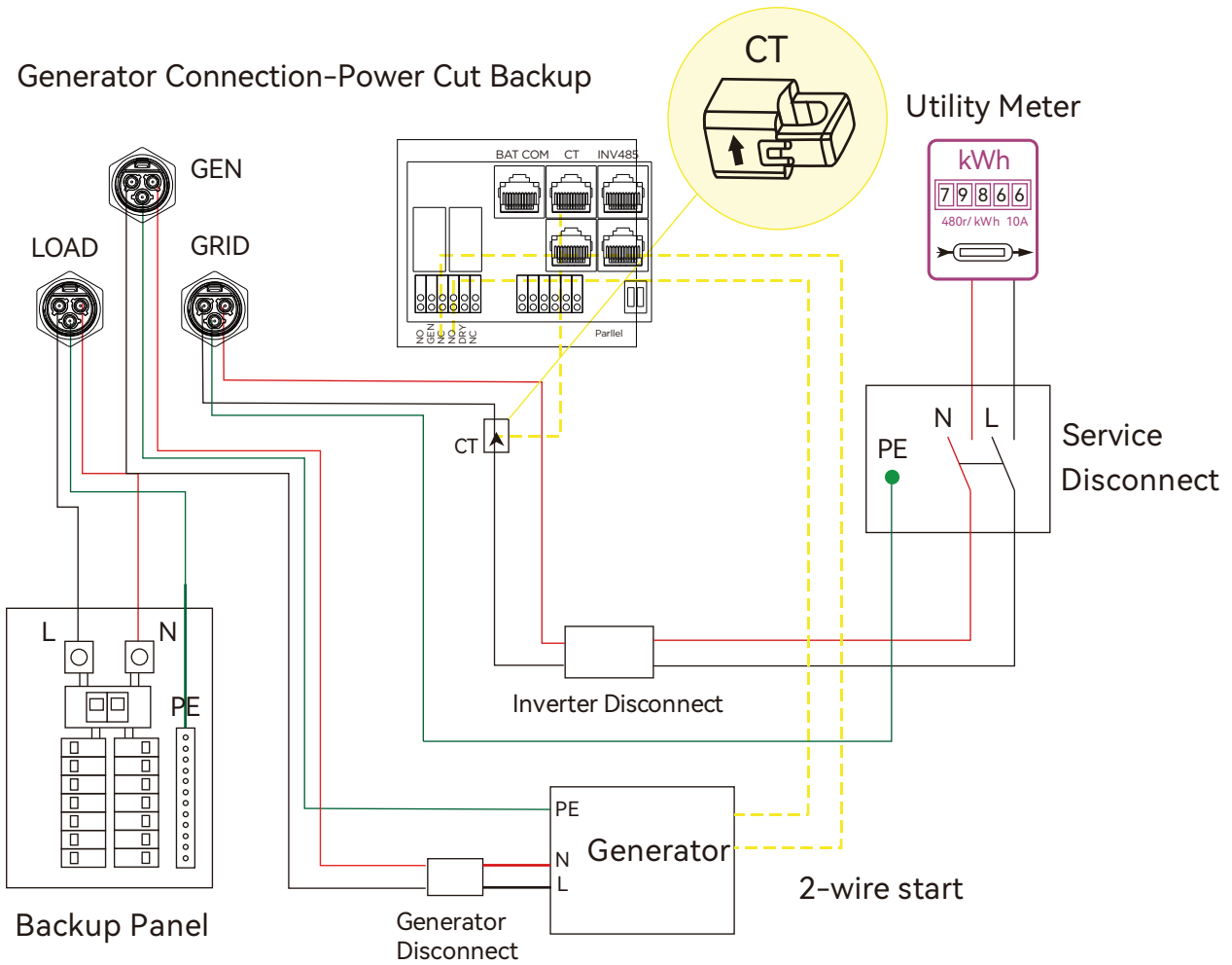

When generator is started, all the loads connected to LOAD will be supplied by the generator. Meanwhile battery will be charged.

The pass-through relay on the generator port is 50A. When generator is on, please ensure the total load and charge current will not exceed 50A.

The generator start signal shall connect to COM board GEN(NO,NC port) if users want to start generator remotely.

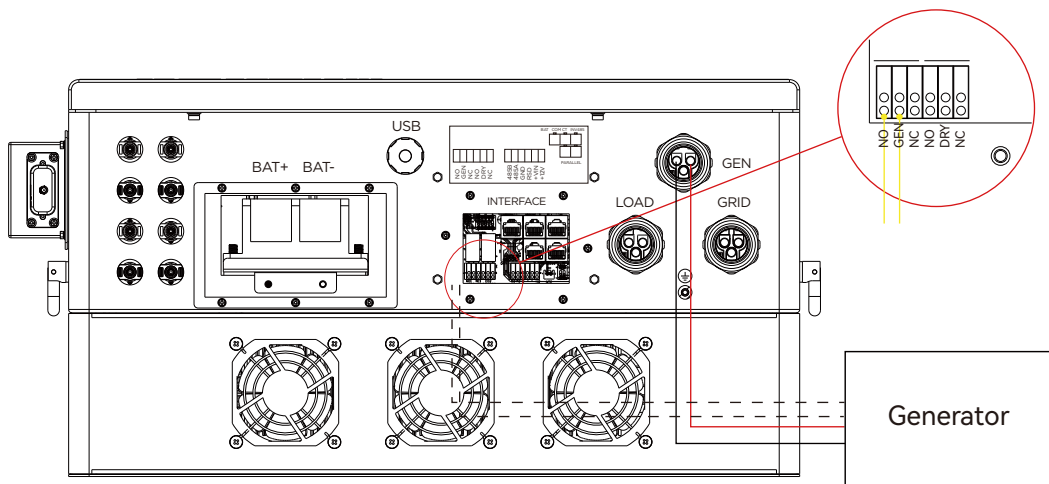

3.7.2 Generator Startup and Stop settings

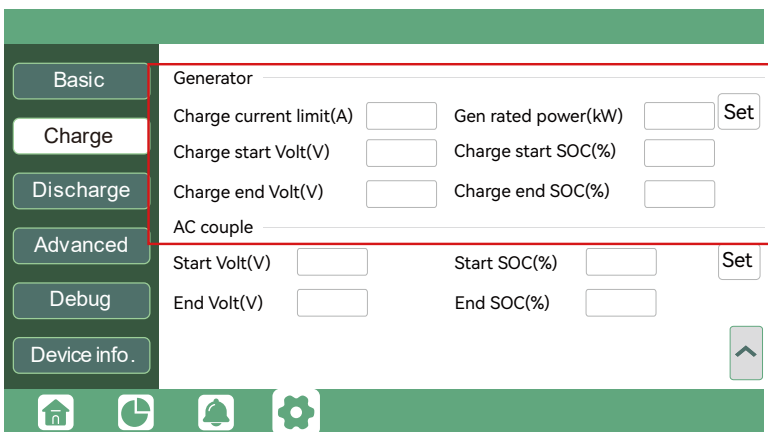
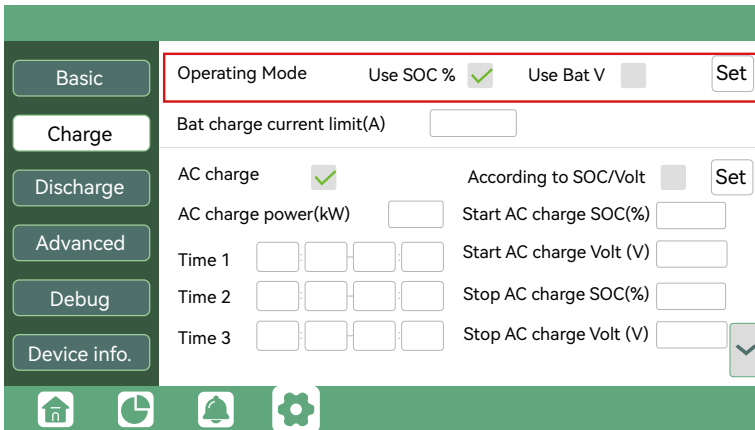

It depends on the Bat operating mode setting, The system will use either battery SOC or battery voltage to determine whether the system needs to start or stop the generator.

Generator Start Conditions

When utility fails and

-When battery is discharged to cut-off settings

or there is force charge request from battery.

or when the battery voltage or SOC is lower than the Generator Charge start Volt/SOC settings,

Generator Stop Conditions

when battery voltage or SOC is higher than Charge end Volt/SOC settings value.

3.8 AC Coupling Installation Connection

The inverter supports AC coupling connection with existing on-grid solar system. The existing solar system is connected to the inverter's GEN port.

Connection for AC coupled solar system

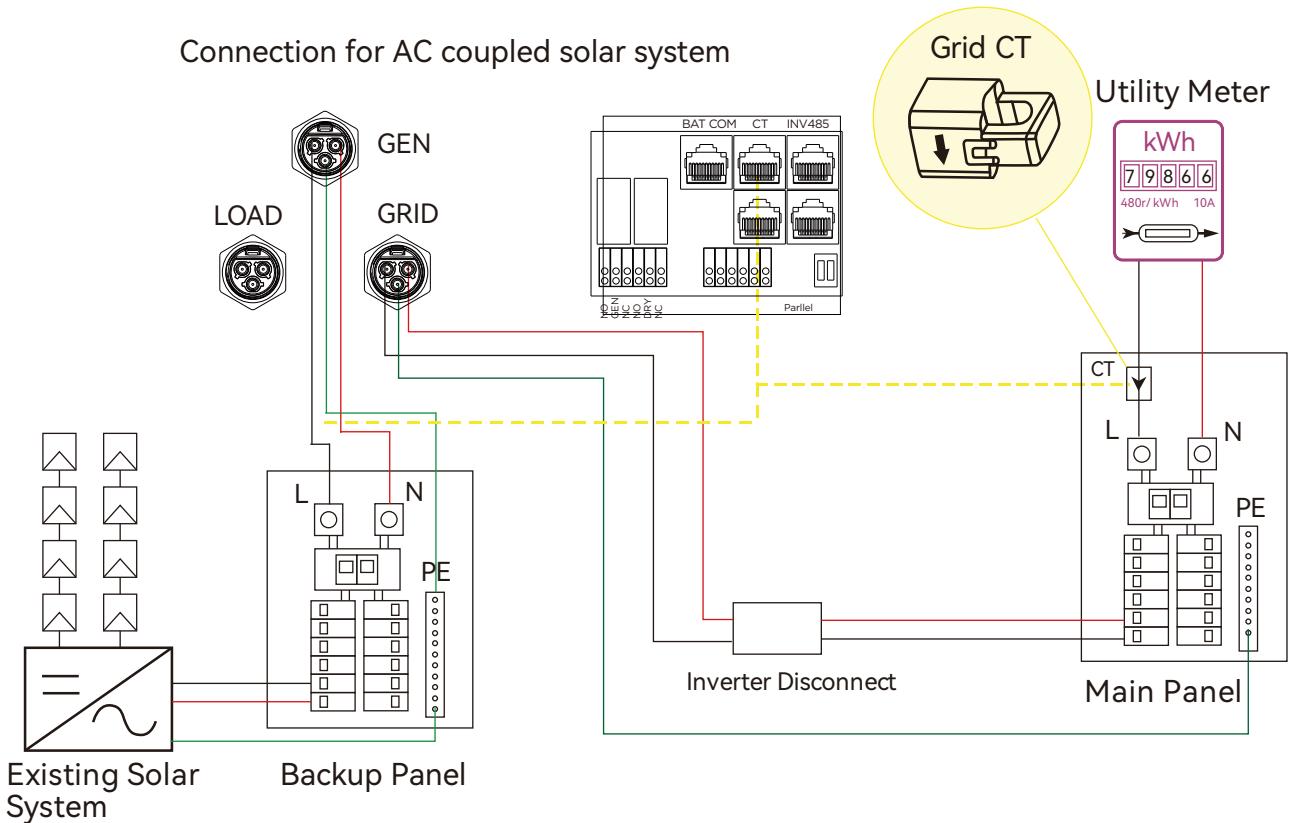

After AC couple function enabled:

When the Grid is on, the GEN terminal is connected to the grid terminal inside the inverter. In this case the hybrid inverter will bypass the interactive inverter AC to the grid and LOAD.

When grid is off, The GEN terminal is connected to the LOAD terminal inside the inverter. In this case, the loads will be first supplied by solar power. If solar panels are generating more power than load consumption, the excess solar power will be stored to the battery. When solar power exceeds the sum of load power and max battery charging power, e.g. when battery is nearly full. The inverter will signal the grid interactive inverter to reduce power via the frequency shifting power reduction mechanism, thus to maintain the balance of generation and consumption of the micro grid system.

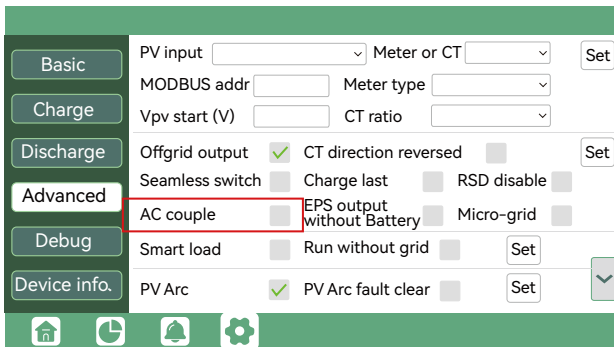

3.9 Parallel System Connection

3.9.1 Connection for paralleling system

The hybrid inverter supports parallel connection to expand power and energy capacity to suit different using scenarios.

The system connection for single-phase paralleling is as below:

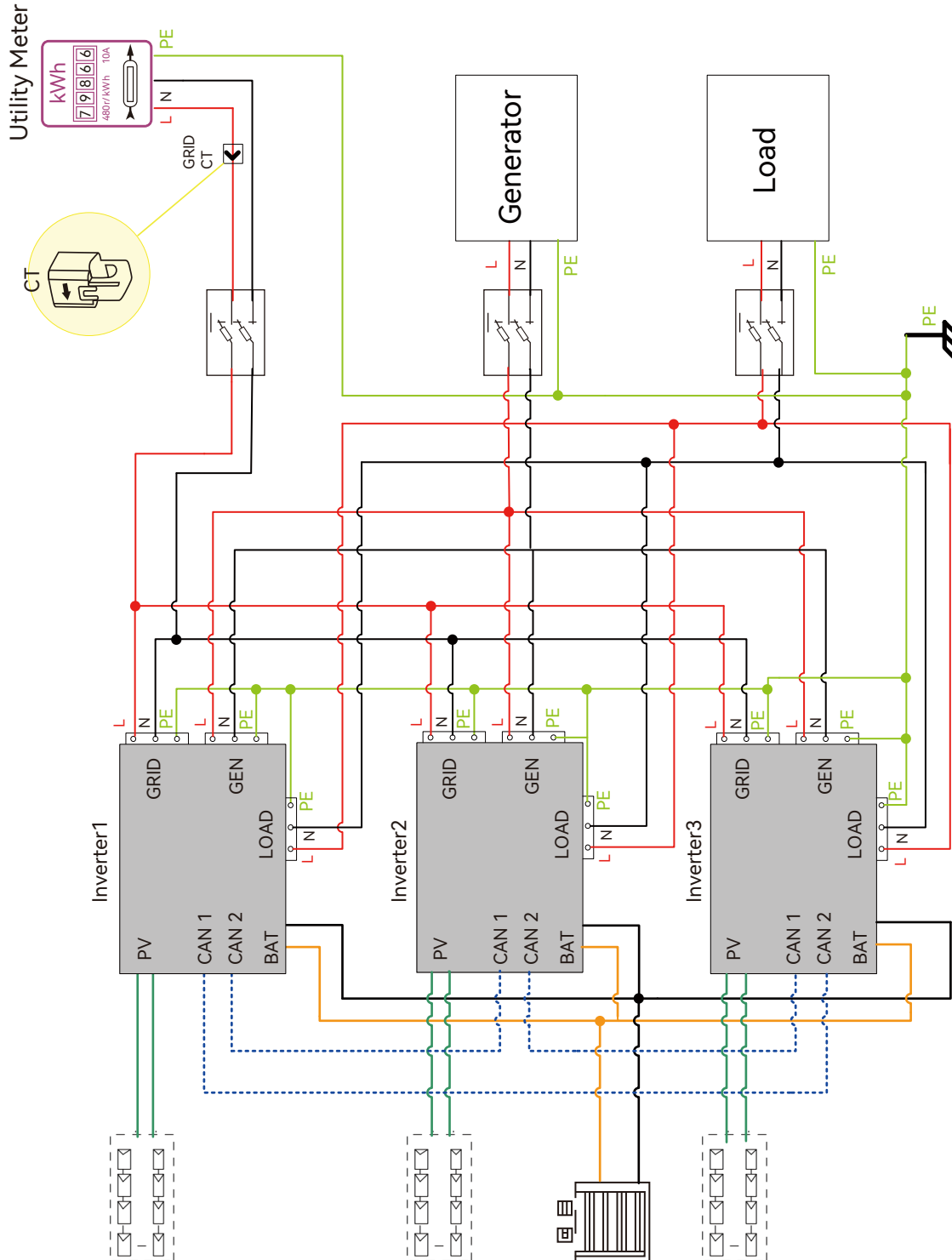

The system connection for three-phase paralleling is as below:

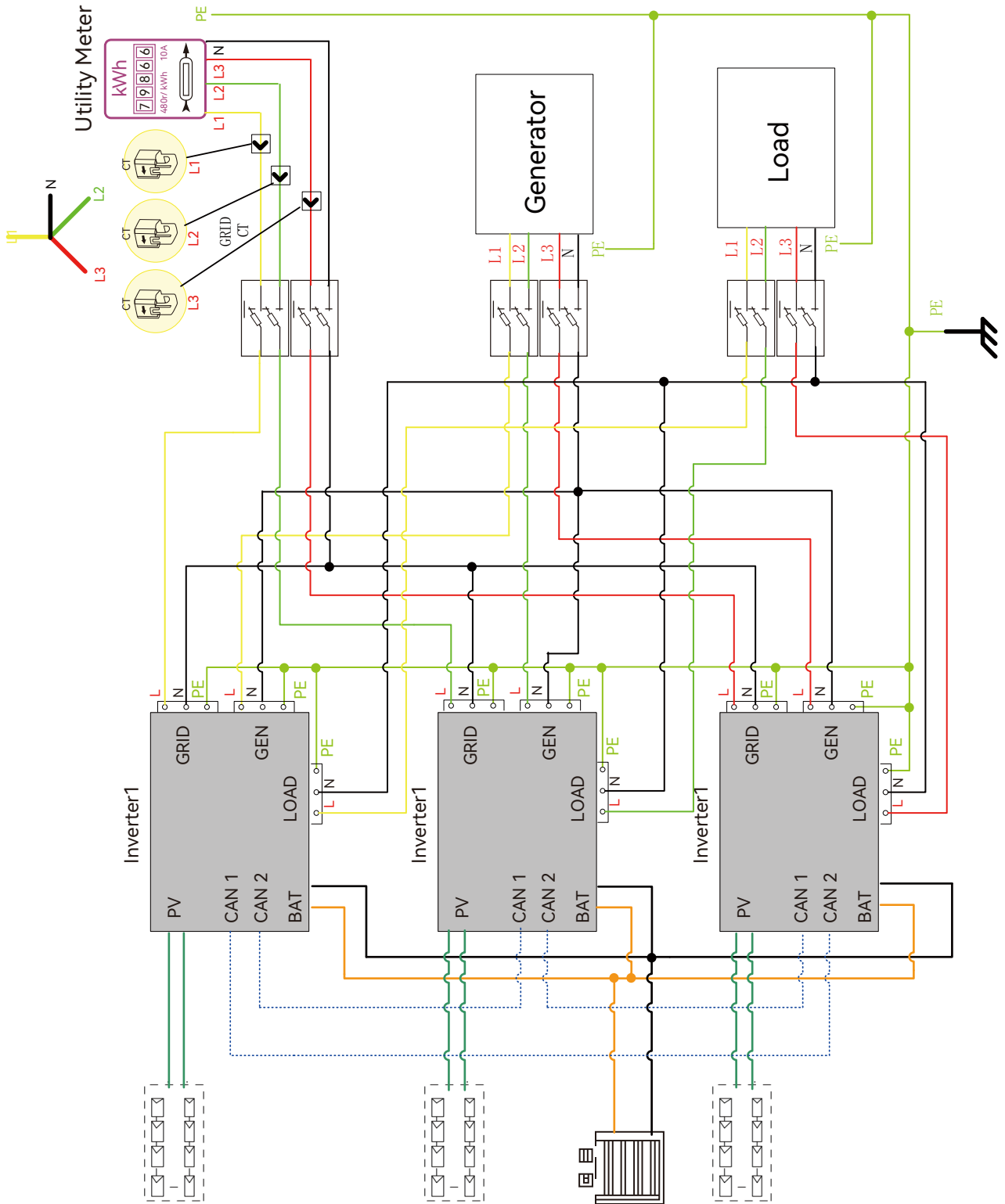

Please put the 2-bit CAN balancing resistor switch to ON status for the first and end inverter of the daisy chain loop.

Please put the CAN communication PIN to ON status for the first and the end inverter

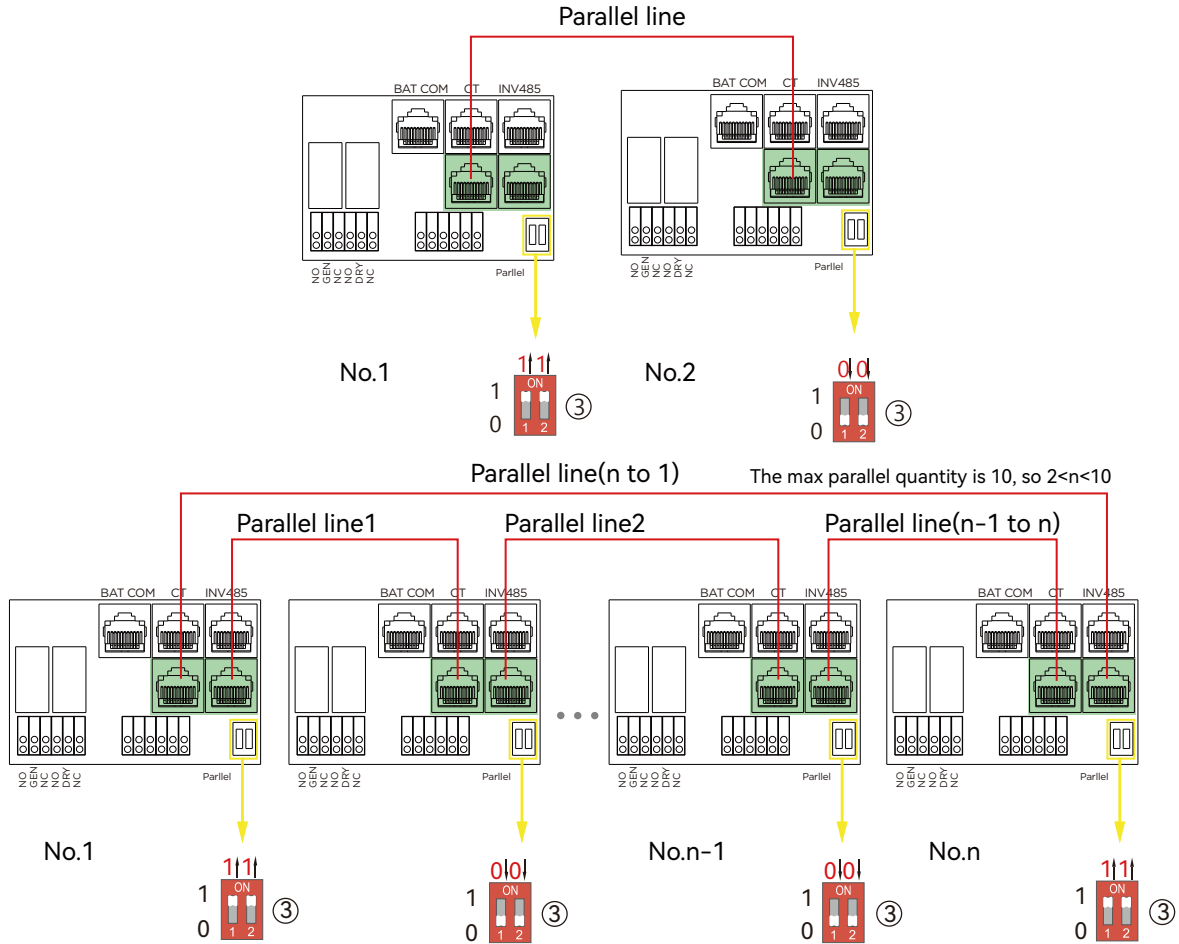

If the parallel cable is not enough or long enough, please make a straight pin to pin cable

Settings for paralleling function in monitor system

1. Set up monitoring for the system, add all dongles into one station. Users can login to visit the monitor system, Configuration->Station->Plant Management->Add dongle to add dongles.

Plant name	Installer	End User	Country	Timezone	Daylight saving time	Create date	Action
1 Genesis			South Africa	GMT+2	No	2019-03-14	Station Management
2 Butler Home	Elangeni	Aspergo Install	South Africa	GMT+2	No	2019-03-25	Station Management
3 Office		johnbutler	South Africa	GMT+2	No	2019-06-03	Station Management
4 Cronje Home	Broomhead		South Africa	GMT+2	No	2019-07-16	Station Management

2. Enable share battery for the system if the system share one battery bank, otherwise disable the shared battery function

3. Set the system as a parallel group in the monitor system

Serial number	Status	Solar Power	Charge Power	Discharge Power	Load	Solar Yield	Battery Dischar	Feed Energy	ConsumptionEr	Station name	Parallel	Action
1 0272011008	Normal	228 W	42 W	0 W	182 W	215.3 kWh	39.6 kWh	0 kWh	551.2 kWh	Dragonview	A-1	Parallel
2 0272011011		35 W	32 W	0 W	0 W	158.7 kWh	21.1 kWh	0 kWh	160.5 kWh	Dragonview	A-2	Parallel
3 0272011012		1 kW	129 W	0 W	1 kW	170.3 kWh	49.9 kWh	0 kWh	434.5 kWh	Dragonview	A-3	Parallel
4 0272011017		79 W	48 W	0 W	106 W	99 kWh	85.6 kWh	0 kWh	257.1 kWh	Dragonview	A-4	Parallel

Please contact your inverter supplier for more detailed guidance for paralleling system

3.10 Monitor System Setup

3.10.1 Wifi/2G/4G/WLAN dongle connection

Users can use WiFi/ WLAN /4G /2G dongle to monitor their inverter, and view the monitoring data on computer or smart phone remotely.

To view data on smartphone, please download the LuxPower APP from Google Play or Apple APP store, then login with their user account.

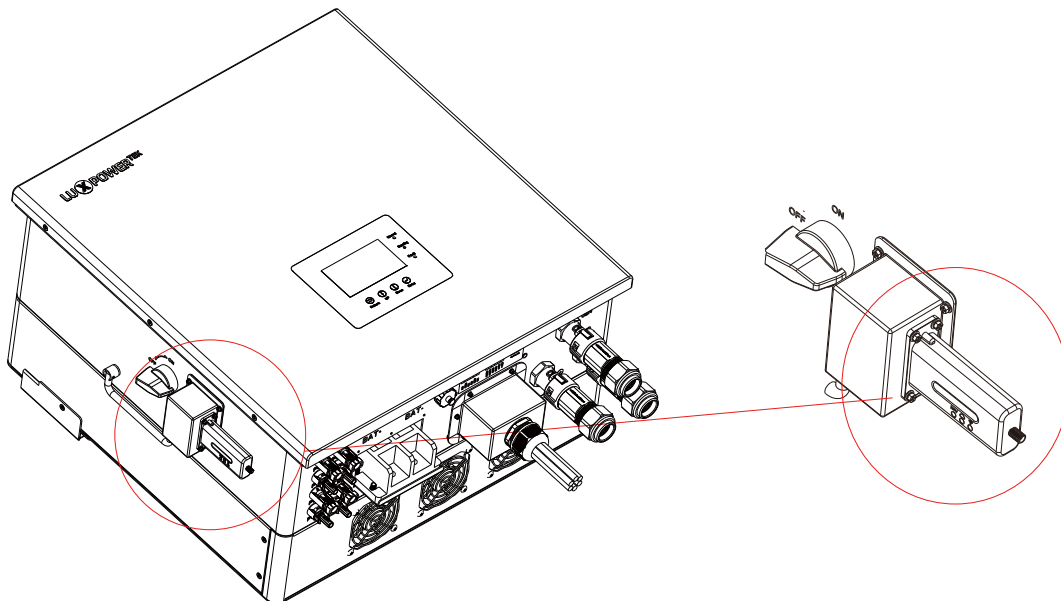

3.10.2 Setup the monitor system

1. Sign up an account on the mobile phone APP or Website

The "customer code" is a code we assigned to your distributor or installer. You can contact your supplier for their code.

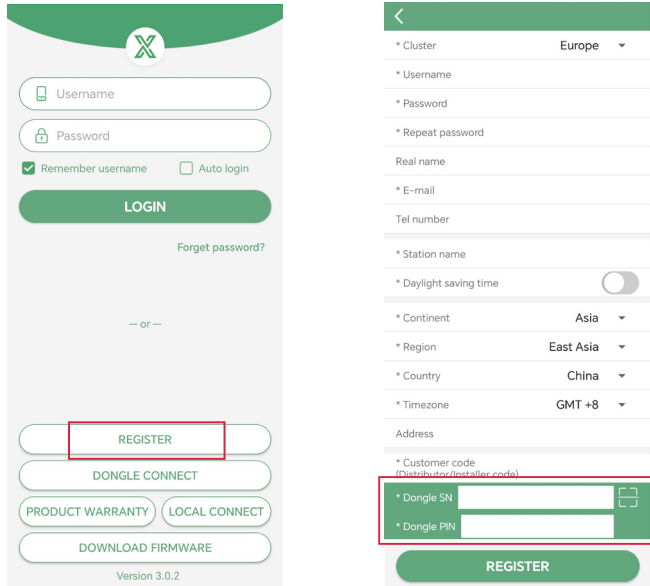

2. Create station and add dongle for the station

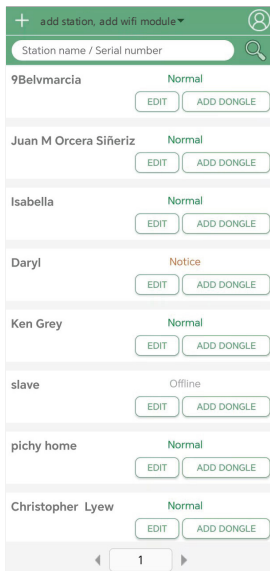

3.10.3 Set homewifi password to dongle

1. Connect your mobile phone to the “BAxxxxxxx” wireless network where “BAxxxxxxx” is the serial number of the WiFi dongle.
2. Click the "WiFi MODULE CONNECT" button on the APP
3. Select the home WiFi that the WiFi dongle is to be connected to, enter the WiFi's password. And then click "HomeWifi Connect". The WiFi dongle will restart and try to connect to our server automatically
4. Check the LEDs' status on the WiFi dongle. The middle light should be solid lit when the WiFi dongle connects to our server successfully

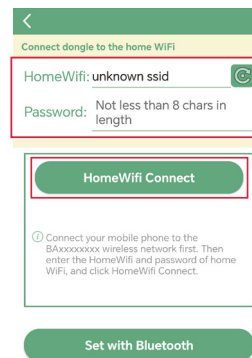
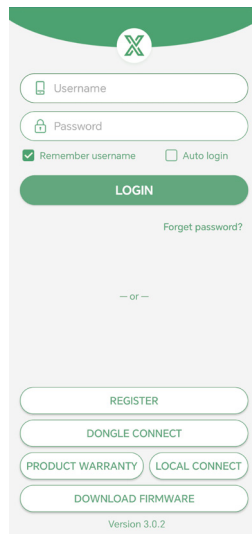
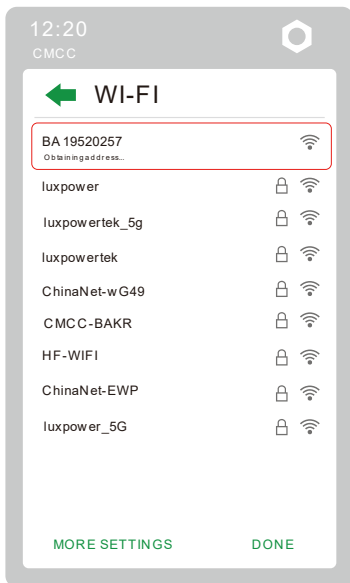

5. Now you can disconnect your mobile phone from the “BAxxxxxxx” wireless network. Login on the APP with your account, you'll find the inverter information already appears. Now you'll be able to monitor and control the inverter remotely on any smart phone or computer that has Internet connection.

Please download the following guides for setting up WiFi dongle and monitoring account at Document Reference:

1. Wifi Quick Guidance

Quick guidance for setting connection of WiFi module to home WiFi, you can also find a printed version in the packaging of the WiFi module.

2. Monitor system setup for Distributors and Monitor system setup for endusers

Account registration, the description of each items and parameters, setting parameters

3. Lux_Monitor_UI_Introduction

Introduction of monitor interface

3.10.4 Third party RS485 communication

Note: This feature is designed specifically for third-party users who wish to use their own monitoring systems. If you plan to undertake independent development, please ensure to contact your distributor to obtain the RS485 communication protocol.

The following two interfaces can be utilized for communication:

Meter 485B and 485A Interfaces: When the entire system is not connected to the meter, these two pins can be used to communicate with the inverter.

INV485 Interface: As this interface is shared with the WIFI module, it can only be used to communicate with the inverter when the WIFI module is not in use.

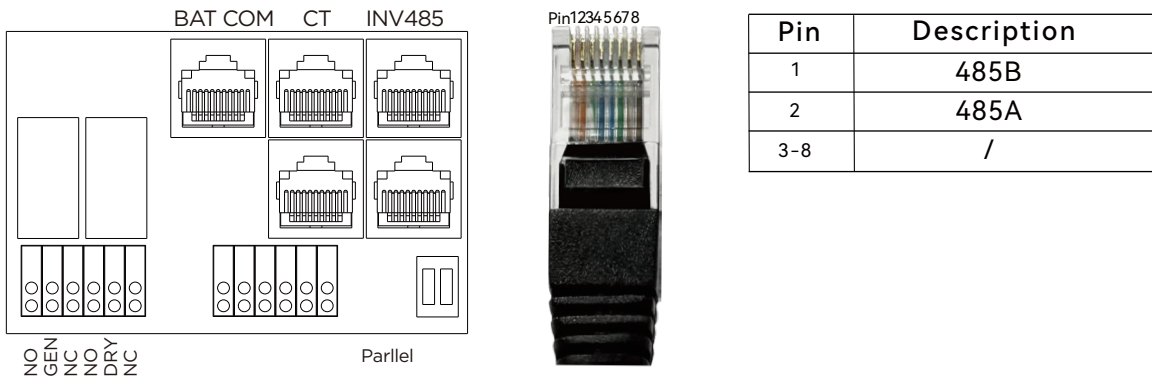

4. Operation Guide

4.1 Operation Mode and Function

The inverter has different working modes to meet customers' various demands, the working modes are as below:

4.1.1 Self-consumption Mode (Default)

In this mode, the priority order of load supply source is Solar >Battery >Grid. The priority order of solar power usage is Load >Battery >Grid.

Application Scenarios

Self consumption mode will increase self consumption rate of solar power and reduce the electricity bill significantly

Related Settings

Effective when Charge Priority, AC Charge, and Forced discharge are disabled

Example

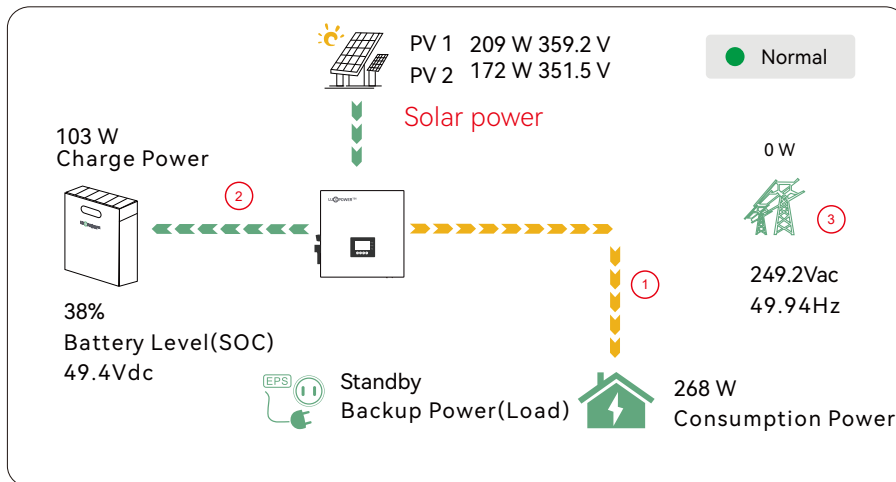

When solar power is enough, solar power will take load, then charge battery, and at last export to grid(when Grid Sell Back function is enabled)

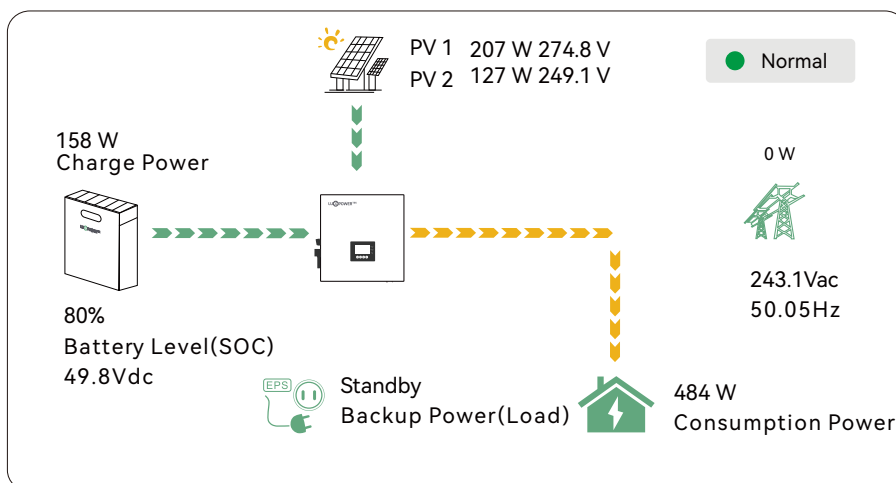

When solar power is enough, solar power will take load, then charge battery, and at last export to grid(when Grid Sell Back function is enabled)

4.1.2 Charge First Mode

The priority order of solar power usage will be Battery >Load >Grid. During the Charge Priority time period, load is first supplied with grid power. If there is excess solar power after battery charging, the excess solar power will take load together with grid power.

Application Scenarios

When users want to use solar power to charge batteries, grid power is used to supply loads.

Related Settings

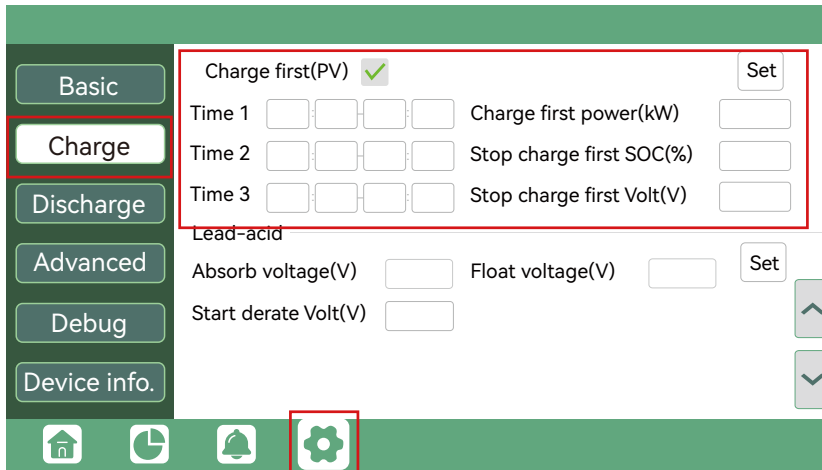

Example

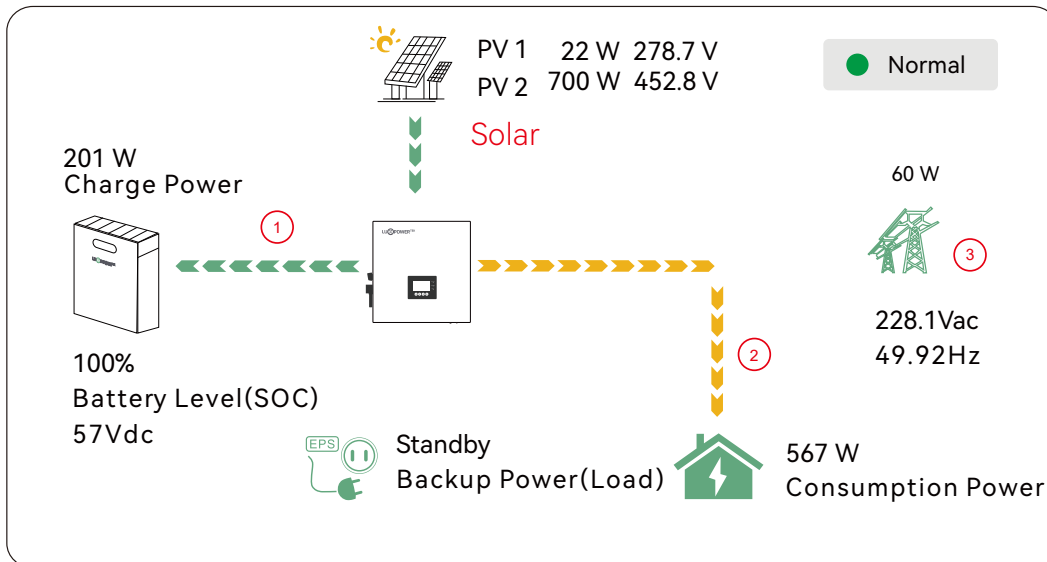

When solar power is enough, solar power will take load, then charge battery, and at last export to grid(when Grid Sell Back function is enabled)

4.1.3 AC Charge Function

(Notes: During the AC charging time period, the battery does not discharge.)

Users can charge battery with grid power when electricity price is cheap, and discharge battery power to supply load or export to the grid when electricity price is high.

Application Scenarios

When users have a Time of Use(TOU) rate plan.

Related Settings

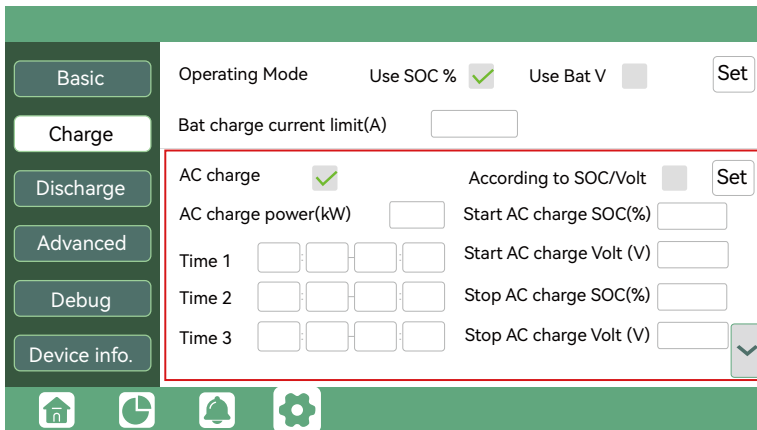

4.1.4 Grid peak-shaving Function

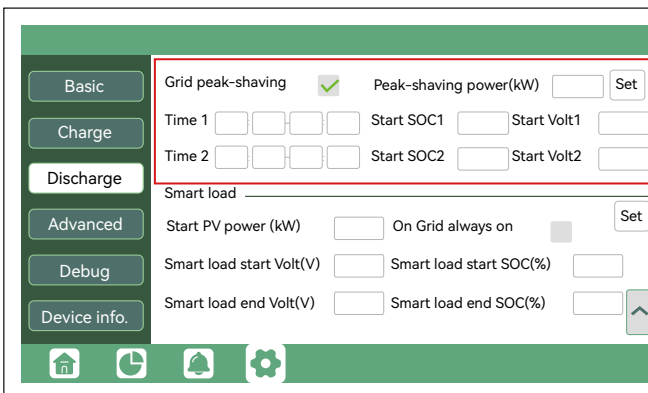

- **Grid peak-shaving & Grid peak-shaving power(kW):** Is used to set the maximum power that the inverter will draw from its grid power. And the Peak-shaving power needs to be set to more than 0.2(KW)

4.1.5 Smart load Function

Smart Load:

This function is to make the Gen input connection point as an load connection point, if you enable it, inverter will supply power to this load when the battery SOC and PV power is above a user setup value. e.g. Smart load start SOC=90%, Smart load end SOC=85%, Start PV power=300W, it means: When the PV power exceeds 300W, and the battery system SOC gets to 90%, the Smart Load Port will switch on automatically to supply the load which is connected on this side. When the battery reaches SOC<85% or PV power<300w, the Smart Load Port switch off automatically.

Note:

If you enable the Smart load function, it's forbidden to connect the generator at the same time, otherwise the device will be damaged!

4.2 LCD Display

Users can view inverter running status, real time power, daily and accumulated energy information conveniently on inverter LCD. In addition to the above information, users can also check alarm and fault record on the display for troubleshooting.

4.2.1 Viewing information and alarm/fault record

Home Page

Touch the screen to light it up if it's in sleep mode. The Home page will appear on the display. Users will see a system overview diagram along with the real time information of each component, such as battery SOC, battery charging/discharging power, grid import/export power, load power, etc. On the right part of the screen, users can check daily and accumulated solar energy, battery charged/discharged energy, grid imported /exported energy, as well as load consumption.

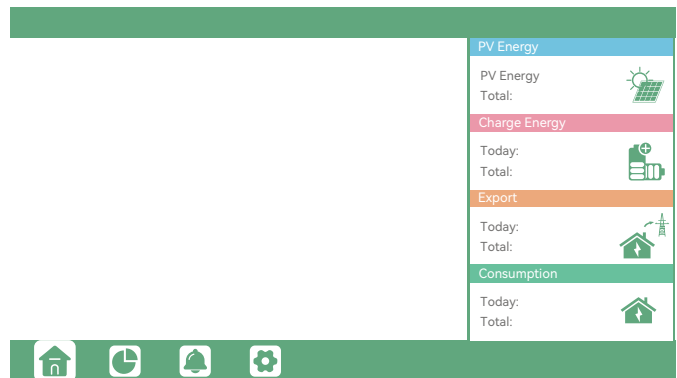

Detailed System Information

Click on the pie icon at the bottom of the screen and, you'll be able to view the detailed real time solar information, battery information, grid information and EPS output information.

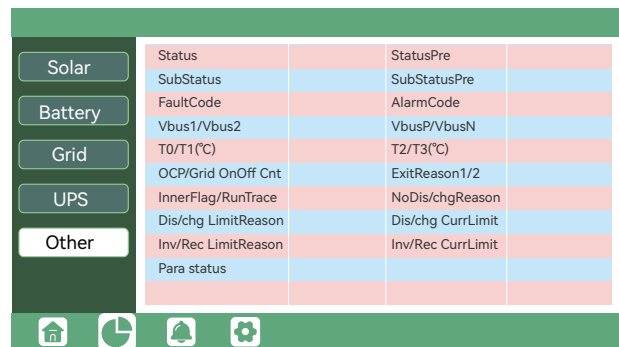
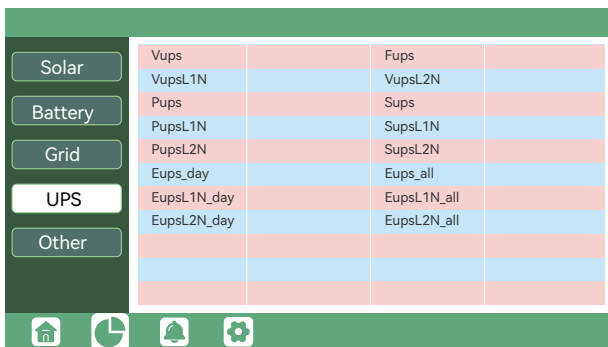
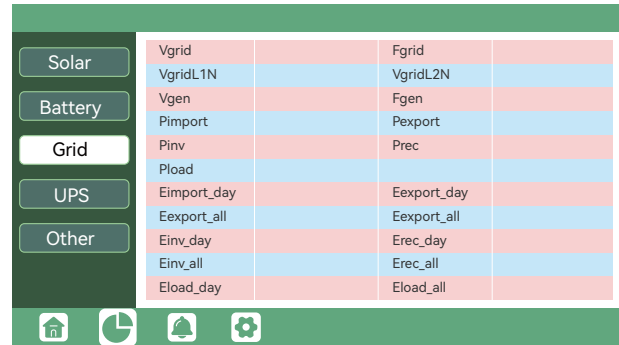

Fault/Alarm Information

Touching the bell icon at the bottom of the screen, you'll see all the current and historical fault & warning information on this page.

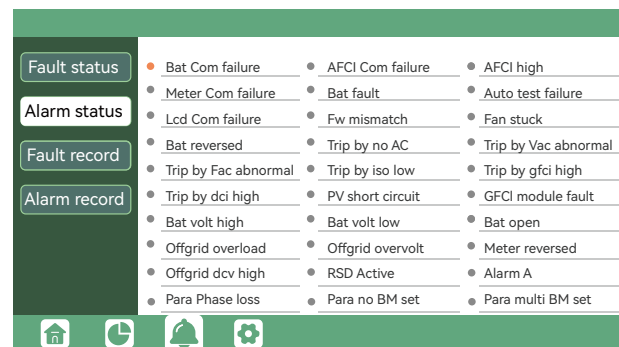
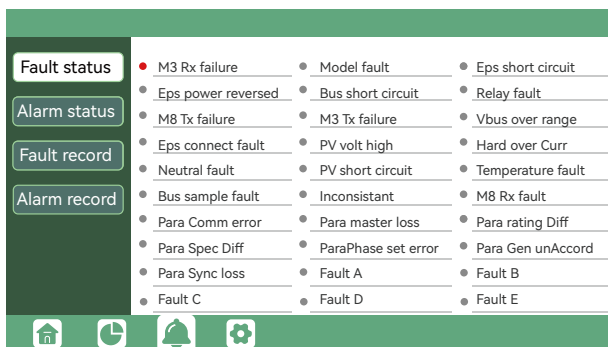

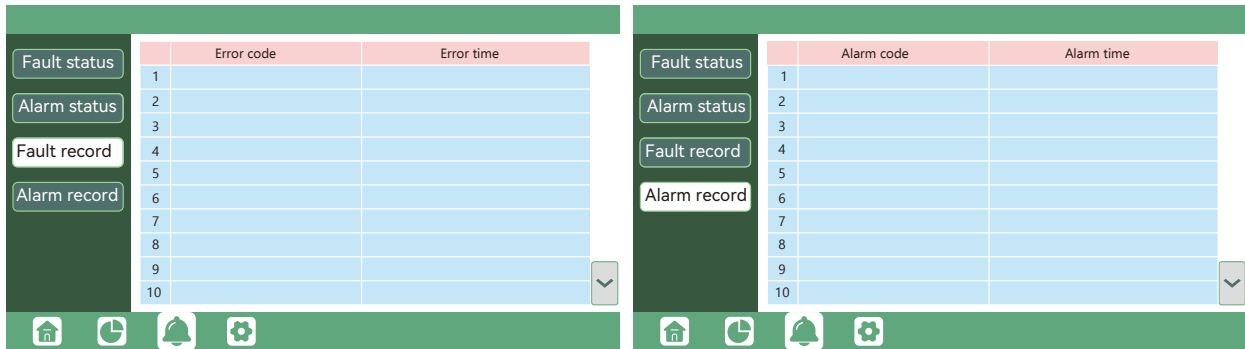

4.2.2 Setting Parameters

Clicking on the gear icon at the bottom of the screen, you'll get into the parameter setting page of the inverter.

a. Basic settings

- **Standby:**
Is for users to set the inverter to normal status or to standby status. In standby status, the inverter will stop any charging or discharging operations, as well as solar-feed-in.
- **Restart inverter:**
Restart the system, please note the power maybe interrupted when restarted.

b. Charge setting

- **Operating Mode :**
Users can decide to use SOC or BatV to control charge and discharge logic depending on battery type.
- **Bat charge current limit(A):**
Users can set Max charge current.
- **AC Charge:**
If users want to use grid power to charge their battery, then they can enable "AC Charge", set time periods when AC charging can happen, AC Charge power(kW) to limit utility charging power, and "Stop AC Charge SOC(%)" as the target SOC for utility charging. "Stop AC Volt(V)" as the target battery voltage for utility charging.

- Charge first:**
 PV charge configuration. When using enable Charge first, PV will charge the battery as a priority, set time periods when PV charge can happen, charge first power(kW) to limit PV charge power, and "Charge first SOC(%)" as the target SOC for PV charge first. "Charge first Volt(V)" as the target battery voltage for PV Charge first.
- Lead acid:**
 When using Lead-acid battery, you need to set parameters in these programs, Follow the battery manufacturer's recommendation.

- Generator:**
 - Bat charge current limit(A):** Set the Max. battery charge current from the Generator. The Generator will start charging according to the Charge start Volt/SOC, and stop charging when the battery voltage or SOC reaches the Charge end Volt/SOC value.
 - Gen rated power:** Enter the rated power of the generator after connecting it.

c. Discharge setting

- Discharge current limit(A):**
 The Max. discharge current from battery
- Discharge start power(W):**
 The Min. value can be set to 50. When the inverter detects the import power is higher than this value, battery start discharging, otherwise battery will keep standby
- On-grid Cut-off(%) and Off-grid Cut-off(%) / On-grid Cut-off(V) and Off-grid Cut-off(V):**
 End of discharge SOC/Cut off voltage in on-grid and off-grid condition respectively.
- Forced discharge:**
 Settings for battery force discharge within certain time period. In the preset time period, the inverter will discharge battery at the power set by "discharge power", until battery SOC or voltage reaches "Stop discharge" value.

- Operating Mode**
 You can choose "Use SOC %" or Use Bat V" to control the battery discharge state

d. Advanced setting

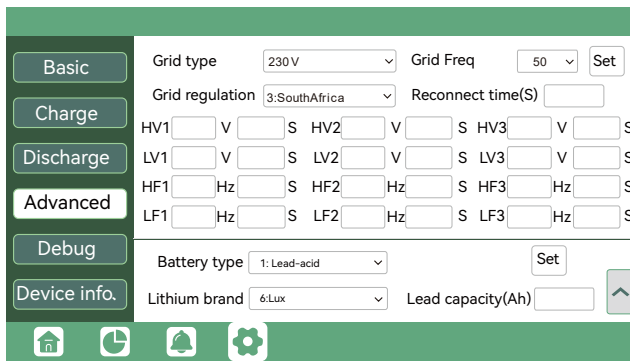

- **Grid type:**
You can choose by yourself, 240/120V, 208/120V,
- **Battery type:**
No battery, lead-acid or lithium-ion.
 - If lead-acid battery is selected, please input correct battery capacity
 - If lithium-ion battery is selected, please choose the battery brand in the Lithium brand drop down list.

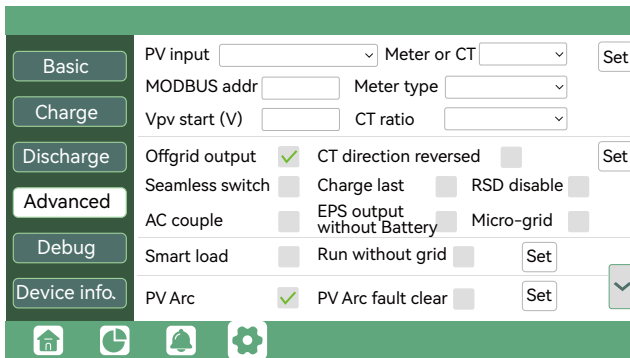

The supported CT ratio is 1000:1, 2000:1, 3000:1. default CT ratio is 3000:1. If 3rd party CT is to be used, please ensure its CT ratio is one of them, and set it accordingly. The battery brand in the Lithium brand drop down list.

- **Meter type:** Please select it according to the meter that's to be installed.
- **Charge last:** When users want to use solar power in the order of loads -- grid export -- battery charging.

- **Offgrid output:**
It is for users to set if the inverter provides backup power or not when the grid is lost. If users want the load to be seamlessly transferred to the inverter backup power, "Seamless switch" must be enabled. If customers don't have a battery installed yet, but still wish to have inverter backup power with only solar panels connected, "PV Grid Off" can be enabled to use solar power to supply load when the grid fails or load-shedding happens. Micro-grid: only needs to be set when the generator is connected to the inverter's grid port. With this option enabled, the inverter will use AC power to charge the battery and won't export any power through the grid port if AC power is present at the inverter's grid port.

- **CT direction reversed:**
If the CTs are in a wrong direction which will cause the display to show incorrect information and features of the inverter will not function correctly, the installer can modify it by selecting it(only for direction not CT 1 or CT 2 placement), there is no need to reconnect the CTs and no need to go change it physically, in the order of loads--grid export--battery charging.

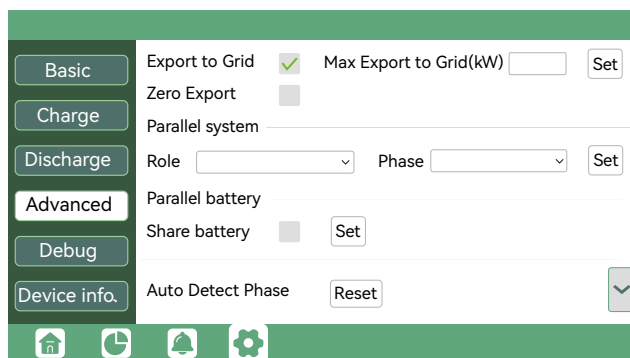

- **Role:** The Role setting of the parallel system. It is set to 1 phase primary by default. In a parallel system, only one inverter is allowed to be set as Primary, and the others are all Subordinate.
- **Share battery:** When the inverter is connected as a parallel system, all inverters need to share the battery, and set the "Share Battery" to "Enable" at the same time

- **Export to Grid:**
This function allows users to enable a zero export feature. If exporting solar power is not permitted, users should disable the "Export to Grid" option. In cases where even a small amount of solar export triggers a trip in the utility meter, "Zero Export" can be enabled. With this setting, export detection and adjustment will occur every 20, milliseconds, effectively preventing any solar power from being exported. If export is allowed, users can enable "Export to Grid" and set a maximum allowable export limit in "Max Export to Grid(kW)."

- **Phase:** This is the phase code setting of the LOAD output. The system will automatically detect the phase sequence of the inverter (consistent with the phase sequence of the connected Grid mains) and display on the inverter after it is connected to the grid

4.3 Start-up and shut down the inverter

4.3.1 Start up the inverter

Step 1. Turn on the battery system firstly, then turn on the DC breaker between battery and inverter.

Step 2. Make sure the PV voltage of the strings are higher than 120V, and check if the inverter works in PV charge or PV charge back-up mode.

Step 3. Make sure step 1 and 2 above work properly before turning on the grid power or generator breaker, and check if the inverter can go to bypass mode and on-grid mode normally.

4.3.2 Shut down the inverter

If there is an emergency issue that necessitates shutting down the inverter, please follow the steps outlined below. **Danger:** when operating under load, please refrain from attempting to use a direct connection method to the terminals of the battery, PV, and AC input for shutting down the inverter.

Step 1. Turn off the Grid breaker of the inverter.

Step 2. Switch off the load breaker.

Step 3. Turn off PV breaker and then battery breaker, waiting for the LCD to go off.

5. Troubleshooting & Maintenance

5.1 Regular Maintenance





- **Inverter Maintenance**

<p>a. Check the inverter every 6 months or 1 year to verify if there are damages on cables, accessories, terminals and the inverter itself.</p>	<p>b. Check the inverter every 6 months to verify if the operating parameter is normal and there is no abnormal heating or noise from the inverter.</p>
<p>c. Check the inverter every 6 months to confirm there is nothing that covers the inverter heat sink, if there is, shut-down the inverter and clear the heat sink.</p>	

- **Battery Maintenance**

Follow the manufacturer's requirements on maintenance. When you carry out these works on batteries, please make sure to fully shut-down the inverter for safety consideration.

5.2 LED Displays

LED	Display	Description	Suggestion
Green LED	Solid lit 	Working normally	
	Flashing 	Firmware upgrading	Wait till upgrading complete
Yellow LED	Solid lit 	Warning, inverter working	Need troubleshooting
Red LED	Solid lit 	Fault, inverter stop work	Need troubleshooting

5.3 Troubleshooting Based On LCD Displays

Once there is any warning or fault occurring, users can troubleshoot according to the LED status and the warning/fault information on the LCD.

1. Fault on the LCD

If the dot on the left of fault item is red, it means the fault is active. When it is grey, it means the fault is defective.

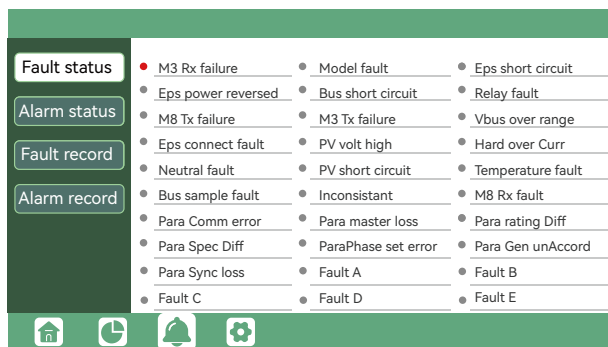

Fault	Meaning	Troubleshooting
M3 Rx failure	M3 microprocessor fails to receive data from DSP	Restart inverter, if the error still exists, contact Luxpower service or your inverter supplier.
Model fault	Incorrect model value	
LOAD short circuit	Inverter detected short-circuit on LOAD output terminals	1. Check if the L1, L2 and N wires are connected correctly at inverter LOAD output port; 2. Disconnect the LOAD breaker to see if fault remains. If fault persists, contact Luxpower service or your inverter supplier.
LOAD power reversed	Inverter detected power flowing into LOAD port	Restart inverter, if the error still exists, contact Luxpower service or your inverter supplier.
Bus short circuit	DC Bus is short circuited	
Relay fault	Relay abnormal	
M8 Tx failure	DSP fails to receive data from M8 microprocessor	
M3 Tx failure	DSP fails to receive data from M3 microprocessor	
Vbus over range	DC Bus voltage is too high	Please check if the PV string voltage is within the inverter specification. If string voltage is within range, and this fault still appears, contact Luxpower service or your inverter supplier.
LOAD connect fault	LOAD port and grid port are connected mixed up	Check if the wires on LOAD port and grid port are connected correctly. If the error exists, contact Luxpower service or your inverter supplier.
PV volt high	PV voltage is too high	Please check if the PV string voltage is within the inverter specification. If string voltage is within range, and this fault still appears, contact Luxpower service or your inverter supplier.
Hard over curr	Hardware level over current protection triggered	Restart inverter, if the error still exists, contact Luxpower service or your inverter supplier.
Neutral fault	Voltage between N and PE is greater than 30V	Check if the neutral wire is connected correctly.
PV short circuit	Short circuit detected on PV input	Disconnect all PV strings from the inverter. If the error persists, contact Luxpower service or your inverter supplier.
Temperature fault	Heat sink temperature is too high	Install the inverter in a place with good ventilation and having no direct sunlight. If the installation site is okay, please check if the NTC connector inside the inverter is loose.
Bus sample fault	Inverter detected DC bus voltage lower than PV input voltage	Restart inverter, if the error still exists, contact Luxpower service or your inverter supplier.
Inconsistent	Sampled grid voltage values of DSP and M8 microprocessor are inconsistent	
M8 Rx fault	M8 microprocessor fails to receive data from DSP	

2. Alarm on the LCD

If the dot on the left of fault item is yellow, it means the fault is active. When it is grey, it means the fault is deactive

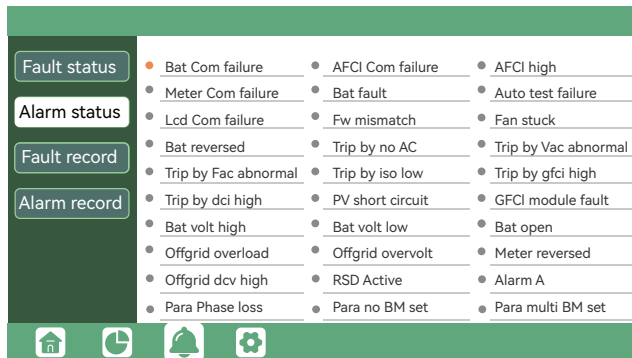

Fault	Meaning	Troubleshooting
Bat com failure	Inverter fails to communicate with battery	Check if communication cable is correct, and if you have chosen the correct battery brand on inverter LCD. If all is correct but this error persists, please contact Luxpower service or your inverter supplier.
Meter com failure	Inverter fails to communicate with the meter	1. Check if the communication cable is connected correctly and in good condition. 2. Restart inverter. If the fault persists, contact Luxpower service or your inverter supplier.
Bat Fault	Battery cannot charge or discharge	1. Check the battery communication cable for correct pinout on both inverter and battery end; 2. Check if you have chosen an incorrect battery brand; 3. Check if there is fault on battery's indicator. If there is fault, please contact your battery supplier.
Auto test failure	Auto test failed	Only applied to Italy model
Lcd com failure	LCD fails to communicate with M3 microprocessor	Restart inverter. If fault still exists, contact Luxpower service or your inverter supplier.
Fwm mismatch	Firmware version mismatch between the microprocessors	
Fan stuck	Cooling fan(s) are stuck	
Trip by gfci high	Inverter detected leakage current on AC side	1. Check if there is ground fault on grid and load side; 2. Restart inverter. If the fault remains, contact Luxpower service or your inverter supplier.
Trip by dci high	Inverter detected high DC injection current on grid port	Restart inverter. If the fault remains, contact Luxpower service or your inverter supplier.
PV short circuit	Inverter detected short circuited PV input	1. Check if each PV string is connected correctly; 2. Restart inverter. If the fault remains, contact Luxpower service or your inverter supplier.

GFCI module fault	GFCI module is abnormal	Restart inverter. If fault still exists, contact Luxpower service or your inverter supplier.
Bat volt high	Battery voltage is too high	Restart inverter. If fault still exists, contact Luxpower service or your inverter supplier.
Bat volt low	Battery voltage is too low	Restart inverter. If fault still exists, contact Luxpower service or your inverter supplier.
Bat open	Battery is disconnected from inverter	Restart inverter. If fault still exists, contact
Offgrid overload	Overload on EPS port	Restart inverter. If fault still exists, contact Luxpower service or your inverter supplier.
Offgrid overvolt	EPS voltage is too high	Restart inverter. If fault still exists, contact Luxpower service or your inverter supplier.
Meter reversed	Meter is connected reversely	Restart inverter. If fault still exists, contact Luxpower service or your inverter supplier.
Offgrid dcv high	High DC voltage component on EPS output when running off-grid	Restart inverter. If fault still exists, contact Luxpower service or your inverter supplier.

PV Input data	GEN-LB-EU 7K	GEN-LB-EU 8K	GEN-LB-EU 10K
Max. usable input current(A)	25/25	25/25	25/25
Max. short circuit input current(A)	34/34	34/34	34/34
Start input voltage(V)	100	100	100
Startup voltage(V)	140	140	140
Full power MPPT voltage range(V)	170-480	170-480	200-480
DC nominal voltage(V) MPPT tracker	360	360	360
DC voltage range(V)	100-600	100-600	100-600
MPP operating voltage range(V)	120-500	120-500	120-500
Max. power(W)	12000	12000	15000
Number of MPPT	2	2	2
Inputs per MPPT	2/2	2/2	2/2
Grid Input/ outpvput data			
Nominal Output Current(A)	30.4	34.7	43.5
Max. Output Current(A)	38.5	38.5	47.8
Rated voltage(V)	230	230	230
Operating voltage range(V)	180-270	180-270	180-270
Nominal power output(W)	7000	8000	8000
Operating frequency(Hz)	50/60	50/60	50/60
Operating frequency range(Hz)	45-55/55-65	45-55/55-65	45-55/55-65
Phase shift	0.99@full load	0.99@full load	0.99@full load
Reactive power adjust range	-0.8~+0.8 leading Adjustable	-0.8~+0.8 leading Adjustable	-0.8~+0.8 leading Adjustable
THDI	<3%	<3%	<3%
Sync inrush current(A)	35	35	35
UPS AC output data			
Nominal output current(A)	30.4	34.7	43.5
Nominal output voltage(V)	230	230	230
Rated output power(VA)	7000	8000	8000
Operating frequency(Hz)	50/60	50/60	50/60
Peak power(VA)	2xPn, 0.5s	2xPn, 0.5s	2xPn, 0.5s
THDV	<3%	<3%	<3%
Switching Time	<20	<20	<20
Efficiency			
Europe Efficiency	96%	96%	96%
Max. Efficiency @ PV to grid	97.5%	97.5%	97.5%
Max. Efficiency @ battery to grid	94%	94%	94%
MPPT Efficiency	99.9%	99.9%	99.9%
Battery data			
Type	Lead-acid batery/Lithium battery	Lead-acid batery/Lithium battery	Lead-acid batery/Lithium battery
Max. charge current(A)	146	167	210
Max. discharge current(A)	146	167	210
Nominal voltage(V)	48	48	48
Voltage range(V)	40-60	40-60	40-60
Max. voltage(V)	60	60	60
General Data			
Integrated disconnect	DC switch	DC switch	DC switch
Reverse polarity protection	Yes	Yes	Yes
DC switch rating for each MPPT	Yes	Yes	Yes
Output over-voltage protection	Yes	Yes	Yes
Output over current protection	Yes	Yes	Yes
Ground fault monitoring	Yes	Yes	Yes
Grid monitoring	Yes	Yes	Yes
Pole sensitive leakage current Monitoring unit	Yes	Yes	Yes
Dimensions(mm)	584*536*290mm(23.0*21.1*11.4inch)	580*490*265mm(22.8*19.3*10.4inch)	580*490*265mm(22.8*19.3*10.4inch)
Weight(kg)	42.64kg(93.8lbs)	44kg(96.8lbs)	44kg(96.8lbs)
Degree of protection	NEMA4X/IP65	NEMA4X/IP65	NEMA4X/IP65
Cooling concept	Smart cooling	Smart cooling	Smart cooling
Topology	Transformer-less	Transformer-less	Transformer-less
Relative humidity	0-100%	0-100%	0-100%
Altitude(m)	<2000m	<2000m	<2000m
Noise emission(dB)	<50dB	<50dB	<50dB
Internal consumption(W)	<15W	<15W	<15W
Display	Touch color screen	Touch color screen	Touch color screen
Communication interface	Rs485/Wi-Fi/CAN	Rs485/Wi-Fi/CAN	Rs485/Wi-Fi/CAN
Standard warranty	5years	5years	5years

■ YOUR RELIABLE ENERGY SOLUTIONS PARTNER



Lux Power Technology Co., Ltd
Headquarter: +86 755 8520 9056
www.luxpowertek.com
Contact us: info@luxpowertek.com



092.20039AA